

Dual Common Cathode diodes Power Module

$V_{RRM} = 1000V$
 $I_C = 400A @ T_c = 70^\circ C$



Application

- Uninterruptible Power Supply (UPS)
- Induction heating
- Welding equipment
- High speed rectifiers

Features

- Ultra fast recovery times
- Soft recovery characteristics
- High blocking voltage
- High current
- Low leakage current
- Very low stray inductance
 - Symmetrical design
 - M5 power connectors
- High level of integration

Benefits

- Outstanding performance at high frequency operation
- Low losses
- Low noise switching
- Direct mounting to heatsink (isolated package)
- Low junction to case thermal resistance
- RoHS Compliant

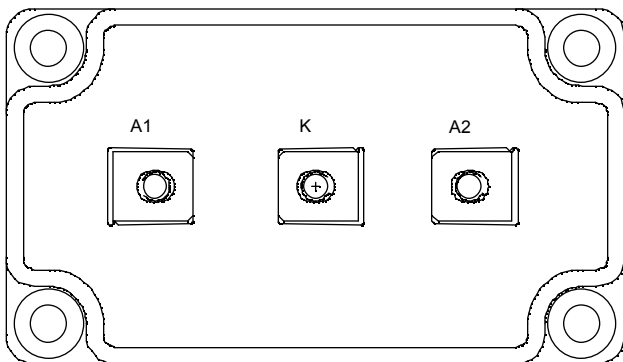

Absolute maximum ratings

Symbol	Parameter			Max ratings	Unit
V_R	Maximum DC reverse Voltage			1000	V
V_{RRM}	Maximum Peak Repetitive Reverse Voltage				
$I_{F(AV)}$	Maximum Average Forward Current	Duty cycle = 50%	$T_C = 25^\circ C$	500	A
			$T_C = 70^\circ C$	400	
$I_{F(RMS)}$	RMS Forward Current	Duty cycle = 50%	$T_C = 45^\circ C$	500	
I_{FSM}	Non-Repetitive Forward Surge Current	8.3ms	$T_C = 45^\circ C$	3000	

CAUTION: These Devices are sensitive to Electrostatic Discharge. Proper Handling Procedures Should Be Followed. See application note APT0502 on www.microsemi.com

All ratings @ $T_j = 25^\circ\text{C}$ unless otherwise specified

Electrical Characteristics

<i>Symbol</i>	<i>Characteristic</i>	<i>Test Conditions</i>		<i>Min</i>	<i>Typ</i>	<i>Max</i>	<i>Unit</i>
V_F	Diode Forward Voltage	$I_F = 400\text{A}$			2.1	2.7	V
		$I_F = 600\text{A}$			2.3		
		$I_F = 400\text{A}$	$T_j = 125^\circ\text{C}$		1.7		
I_{RM}	Maximum Reverse Leakage Current	$V_R = 1000\text{V}$	$T_j = 25^\circ\text{C}$			250	μA
			$T_j = 125^\circ\text{C}$			1000	
C_T	Junction Capacitance	$V_R = 1000\text{V}$			480		pF

Dynamic Characteristics

<i>Symbol</i>	<i>Characteristic</i>	<i>Test Conditions</i>		<i>Min</i>	<i>Typ</i>	<i>Max</i>	<i>Unit</i>
t_{rr}	Reverse Recovery Time	$I_F = 1\text{A}, V_R = 30\text{V}$ $di/dt = 400\text{A}/\mu\text{s}$	$T_j = 25^\circ\text{C}$		45		ns
t_{rr}	Reverse Recovery Time	$I_F = 400\text{A}$ $V_R = 667\text{V}$ $di/dt = 800\text{A}/\mu\text{s}$	$T_j = 25^\circ\text{C}$		290		ns
			$T_j = 125^\circ\text{C}$		340		
Q_{rr}	Reverse Recovery Charge		$T_j = 25^\circ\text{C}$		2.7		μC
			$T_j = 125^\circ\text{C}$		14.6		
I_{RRM}	Reverse Recovery Current		$T_j = 25^\circ\text{C}$		24		A
			$T_j = 125^\circ\text{C}$		72		
t_{rr}	Reverse Recovery Time	$I_F = 400\text{A}$ $V_R = 667\text{V}$ $di/dt = 4000\text{A}/\mu\text{s}$	$T_j = 125^\circ\text{C}$		160		ns
Q_{rr}	Reverse Recovery Charge				28.4		μC
I_{RRM}	Reverse Recovery Current				280		A

Thermal and package characteristics

<i>Symbol</i>	<i>Characteristic</i>	<i>Min</i>	<i>Typ</i>	<i>Max</i>	<i>Unit</i>	
R_{thJC}	Junction to Case			0.14	$^\circ\text{C}/\text{W}$	
V_{ISOL}	RMS Isolation Voltage, any terminal to case $t = 1\text{ min}, I_{isol} < 1\text{mA}, 50/60\text{Hz}$	2500			V	
T_j	Operating junction temperature range	-40		175	$^\circ\text{C}$	
T_{STG}	Storage Temperature Range	-40		125		
T_C	Operating Case Temperature	-40		100		
Torque	Mounting torque	To heatsink	M6	3	5	N.m
		For terminals	M5	2	3.5	
Wt	Package Weight			280	g	

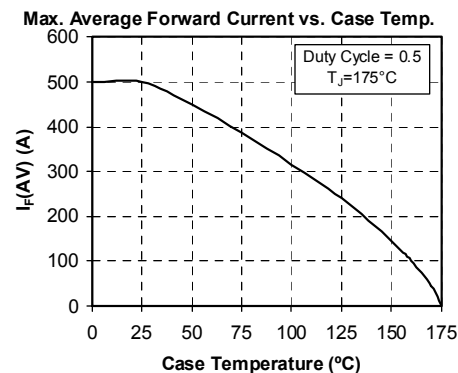
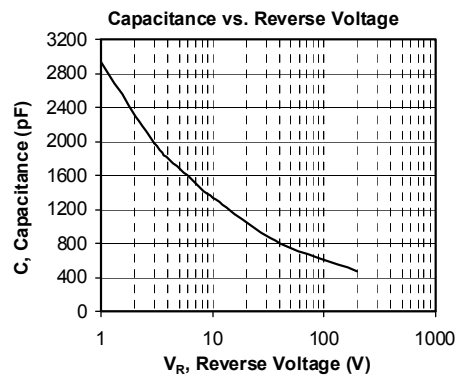
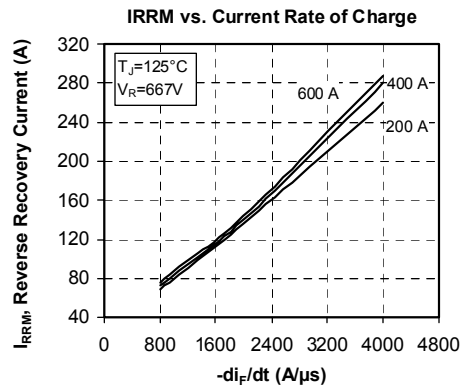
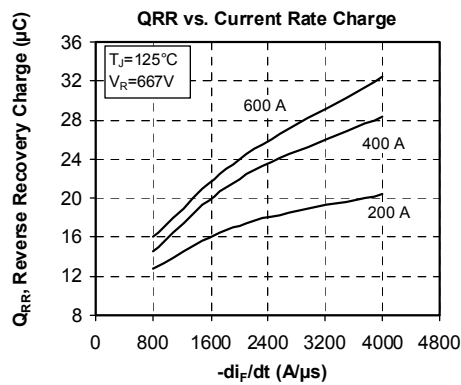
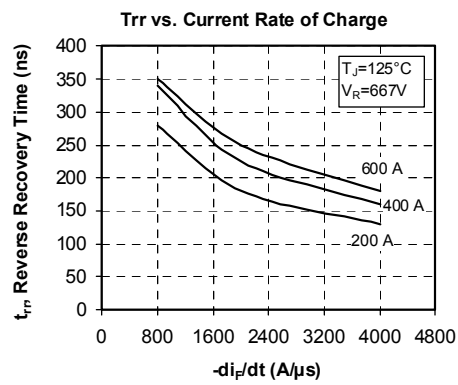
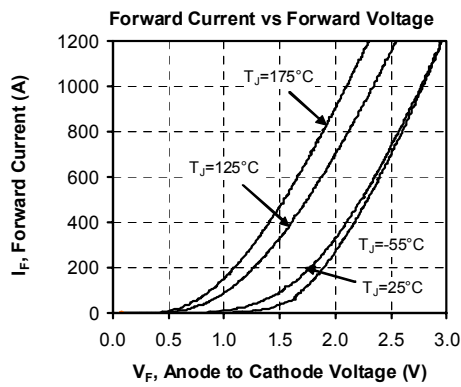
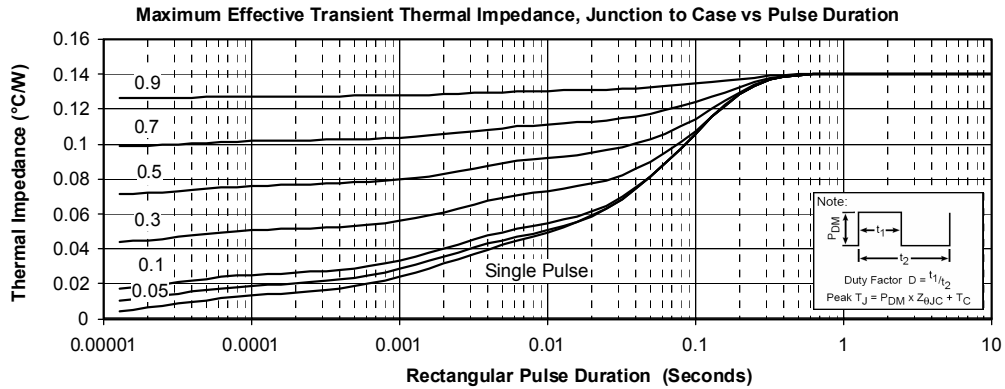
Typical Performance Curve

SP6 Package outline (dimensions in mm)

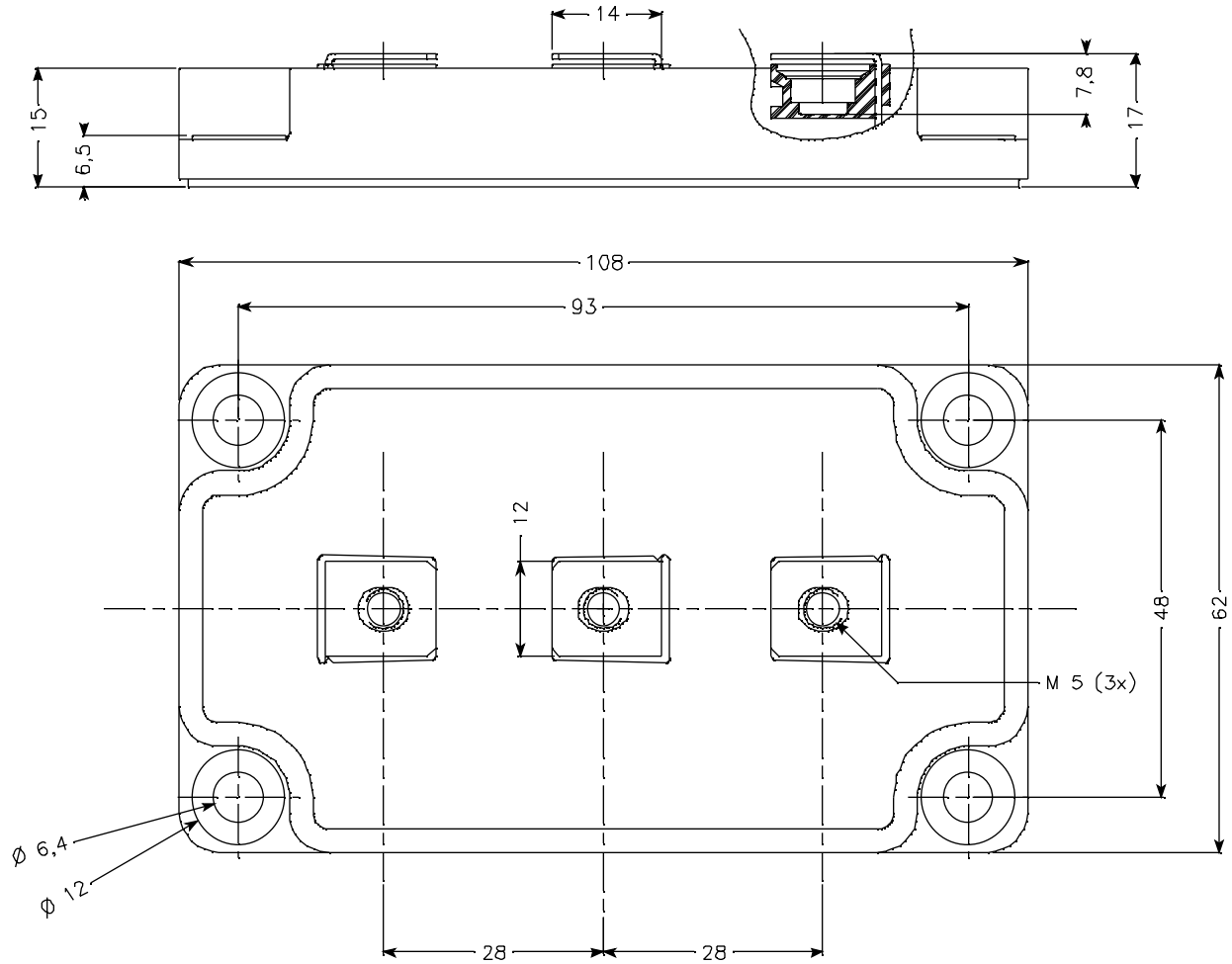

Microsemi reserves the right to change, without notice, the specifications and information contained herein

Microsemi's products are covered by one or more of U.S. patents 4,895,810 5,045,903 5,089,434 5,182,234 5,019,522 5,262,336 6,503,786 5,256,583 4,748,103 5,283,202 5,231,474 5,434,095 5,528,058 and foreign patents. U.S. and Foreign patents pending. All Rights Reserved.