

**ISOTOP® Buck chopper  
NPT IGBT**

**$V_{CES} = 600V$   
 $I_C = 60A @ T_c = 95^\circ C$**

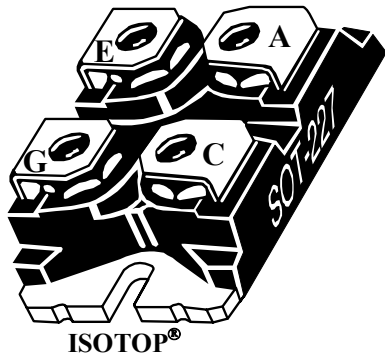
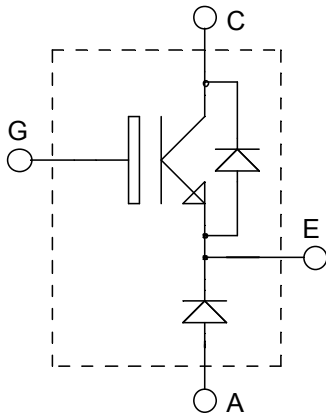

**Application**

- AC and DC motor control
- Switched Mode Power Supplies

**Features**

- Non Punch Through (NPT) THUNDERBOLT IGBT®
  - Low voltage drop
  - Low tail current
  - Switching frequency up to 100 kHz
  - Soft recovery parallel diodes
  - Low diode VF
  - Low leakage current
  - Avalanche energy rated
  - RBSOA and SCSOA rated
- ISOTOP® Package (SOT-227)
- Very low stray inductance
- High level of integration

**Benefits**

- Outstanding performance at high frequency operation
- Stable temperature behavior
- Very rugged
- Direct mounting to heatsink (isolated package)
- Low junction to case thermal resistance
- Easy paralleling due to positive TC of VCEsat

**Absolute maximum ratings**

| Symbol     | Parameter   | Max ratings                       | Unit |
|------------|---|-----------------------------------|------|
| $V_{CES}$  | Collector - Emitter Breakdown Voltage               | 600                               | V    |
| $I_{C1}$   | Continuous Collector Current                        | $T_C = 25^\circ C$                | A    |
| $I_{C2}$   |   | $T_C = 95^\circ C$                |      |
| $I_{CM}$   | Pulsed Collector Current                            | $T_C = 25^\circ C$                | 360  |
| $V_{GE}$   | Gate - Emitter Voltage                              | $\pm 20$                          | V    |
| $P_D$      | Maximum Power Dissipation                           | $T_C = 25^\circ C$                | 378  |
| $I_{LM}$   | RBSOA clamped Inductive load Current $R_G=11\Omega$ | $T_C = 25^\circ C$                | 360  |
| $I_{FAV}$  | Maximum Average Forward Current                     | Duty cycle=0.5 $T_C = 80^\circ C$ | 30   |
| $I_{FRMS}$ | RMS Forward Current (Square wave, 50% duty)         |                                   | 39   |

**CAUTION:** These Devices are sensitive to Electrostatic Discharge. Proper Handling Procedures Should Be Followed.

All ratings @  $T_j = 25^\circ\text{C}$  unless otherwise specified

## Electrical Characteristics

| Symbol       | Characteristic                        | Test Conditions                   | Min | Typ | Max       | Unit    |
|--------------|---------------------------------------|-----------------------------------|-----|-----|-----------|---------|
| $BV_{CES}$   | Collector - Emitter Breakdown Voltage | $V_{GE} = 0V, I_C = 0.5mA$        | 600 |     |           | V       |
| $I_{CES}$    | Zero Gate Voltage Collector Current   | $V_{GE} = 0V$<br>$V_{CE} = 600V$  |     |     | 80        | $\mu A$ |
|              |                                       |                                   |     |     | 2000      |         |
| $V_{CE(on)}$ | Collector Emitter on Voltage          | $V_{GE} = 15V$<br>$I_C = 60A$     |     | 2.0 | 2.5       | V       |
|              |                                       |                                   |     |     | 2.8       |         |
| $V_{GE(th)}$ | Gate Threshold Voltage                | $V_{GE} = V_{CE}, I_C = 500\mu A$ | 3   | 4   | 5         | V       |
| $I_{GES}$    | Gate - Emitter Leakage Current        | $V_{GE} = \pm 20V, V_{CE} = 0V$   |     |     | $\pm 100$ | nA      |

## Dynamic Characteristics

| Symbol       | Characteristic               | Test Conditions                             | Min | Typ  | Max  | Unit |
|--------------|------------------------------|---|-----|------|------|------|
| $C_{ies}$    | Input Capacitance            | $V_{GE} = 0V$                               |     | 3125 | 3590 | pF   |
| $C_{oes}$    | Output Capacitance           | $V_{CE} = 25V$                              |     | 310  | 450  |      |
| $C_{res}$    | Reverse Transfer Capacitance | $f = 1MHz$                                  |     | 180  | 310  |      |
| $Q_g$        | Total gate Charge            | $V_{GS} = 15V$                              |     | 257  | 410  | nC   |
| $Q_{ge}$     | Gate - Emitter Charge        | $V_{Bus} = 300V$                            |     | 19   | 30   |      |
| $Q_{gc}$     | Gate - Collector Charge      | $I_C = 60A$                                 |     | 120  | 180  |      |
| $T_{d(on)}$  | Turn-on Delay Time           | Resistive Switching ( $25^\circ\text{C}$ )  |     | 20   | 40   | ns   |
| $T_r$        | Rise Time                    | $V_{GE} = 15V$                              |     | 95   | 190  |      |
| $T_{d(off)}$ | Turn-off Delay Time          | $V_{Bus} = 300V$                            |     | 315  | 470  |      |
| $T_f$        | Fall Time                    | $I_C = 60A$<br>$R_G = 5\Omega$              |     | 245  | 490  |      |
| $T_{d(on)}$  | Turn-on Delay Time           | Inductive Switching ( $25^\circ\text{C}$ )  |     | 26   | 50   | ns   |
| $T_r$        | Rise Time                    | $V_{GE} = 15V$                              |     | 63   | 125  |      |
| $T_{d(off)}$ | Turn-off Delay Time          | $V_{Bus} = 400V$                            |     | 395  | 590  |      |
| $T_f$        | Fall Time                    | $I_C = 60A$<br>$R_G = 5\Omega$              |     | 68   | 140  |      |
| $E_{ts}$     | Total switching Losses       |   |     | 3.4  | 7    | mJ   |
| $T_{d(on)}$  | Turn-on Delay Time           | Inductive Switching ( $150^\circ\text{C}$ ) |     | 25   | 50   | ns   |
| $T_r$        | Rise Time                    | $V_{GE} = 15V$                              |     | 59   | 120  |      |
| $T_{d(off)}$ | Turn-off Delay Time          | $V_{Bus} = 400V$                            |     | 430  | 650  |      |
| $T_f$        | Fall Time                    | $I_C = 60A$<br>$R_G = 5\Omega$              |     | 65   | 130  |      |
| $E_{on}$     | Turn-on Switching Energy     |   |     | 1.6  | 3.2  | mJ   |
| $E_{off}$    | Turn-off Switching Energy    |   |     | 2.4  | 4.8  |      |
| $E_{ts}$     | Total switching Losses       |   |     | 4.0  | 8.0  |      |

**Diode ratings and characteristics**

| <i>Symbol</i>    | <i>Characteristic</i>            | <i>Test Conditions</i>   |                        | <i>Min</i> | <i>Typ</i> | <i>Max</i> | <i>Unit</i> |
|------------------|----------------------------------|--|------------------------|------------|------------|------------|-------------|
| V <sub>F</sub>   | Diode Forward Voltage            | I <sub>F</sub> = 30A   |                        |            | 1.6        | 1.8        | V           |
|                  |                                  | I <sub>F</sub> = 60A   |                        |            | 1.9        |            |             |
|                  |                                  | I <sub>F</sub> = 30A   | T <sub>j</sub> = 125°C |            | 1.4        |            |             |
| I <sub>RM</sub>  | Maximum Reverse Leakage Current  | V <sub>R</sub> = 600V  | T <sub>j</sub> = 25°C  |            |            | 250        | μA          |
|                  |                                  | V <sub>R</sub> = 600V  | T <sub>j</sub> = 125°C |            |            | 500        |             |
| C <sub>T</sub>   | Junction Capacitance             | V <sub>R</sub> = 200V  |                        |            | 44         |            | pF          |
| t <sub>rr</sub>  | Reverse Recovery Time            | I <sub>F</sub> = 1A, V <sub>R</sub> = 30V<br>di/dt = 100A/μs     | T <sub>j</sub> = 25°C  |            | 23         |            | ns          |
|                  | Reverse Recovery Time            |  | T <sub>j</sub> = 25°C  |            | 85         |            |             |
|                  |                                  |  | T <sub>j</sub> = 125°C |            | 160        |            |             |
| I <sub>RRM</sub> | Maximum Reverse Recovery Current | I <sub>F</sub> = 30A<br>V <sub>R</sub> = 400V<br>di/dt = 200A/μs | T <sub>j</sub> = 25°C  |            | 4          |            | A           |
|                  |                                  |  | T <sub>j</sub> = 125°C |            | 8          |            |             |
| Q <sub>rr</sub>  | Reverse Recovery Charge          |  | T <sub>j</sub> = 25°C  |            | 130        |            | nC          |
|                  |                                  |  | T <sub>j</sub> = 125°C |            | 700        |            |             |
| t <sub>rr</sub>  | Reverse Recovery Time            | I <sub>F</sub> = 30A   | T <sub>j</sub> = 125°C |            | 70         |            | ns          |
| Q <sub>rr</sub>  | Reverse Recovery Charge          | V <sub>R</sub> = 400V  |                        |            | 1300       |            | nC          |
| I <sub>RRM</sub> | Maximum Reverse Recovery Current | di/dt = 1000A/μs   |                        |            | 30         |            | A           |

**Thermal and package characteristics**

| <i>Symbol</i>                     | <i>Characteristic</i>   |       | <i>Min</i> | <i>Typ</i> | <i>Max</i> | <i>Unit</i> |
|-----------------------------------|---|-------|------------|------------|------------|-------------|
| R <sub>thJC</sub>                 | Junction to Case  | IGBT  |            |            | 0.33       | °C/W        |
|                                   |   | Diode |            |            | 1.21       |             |
| R <sub>thJA</sub>                 | Junction to Ambient (IGBT & Diode)  |       |            |            | 20         |             |
| V <sub>ISOL</sub>                 | RMS Isolation Voltage, any terminal to case t = 1 min, I <sub>isol</sub> < 1mA, 50/60Hz |       | 2500       |            |            | V           |
| T <sub>J</sub> , T <sub>STG</sub> | Storage Temperature Range   |       | -55        |            | 150        | °C          |
| T <sub>L</sub>                    | Max Lead Temp for Soldering: 0.063" from case for 10 sec                                |       |            |            | 300        |             |
| Torque                            | Mounting torque (Mounting = 8-32 or 4mm Machine and terminals = 4mm Machine)            |       |            |            | 1.5        | N.m         |
| Wt                                | Package Weight  |       |            | 29.2       |            | g           |

**Typical IGBT Performance Curve**

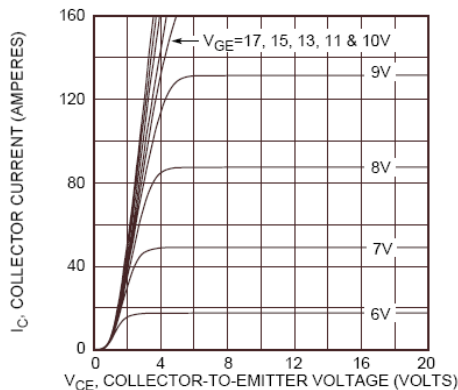

**Figure 1, Typical Output Characteristics ( $T_J = 25^\circ\text{C}$ )**

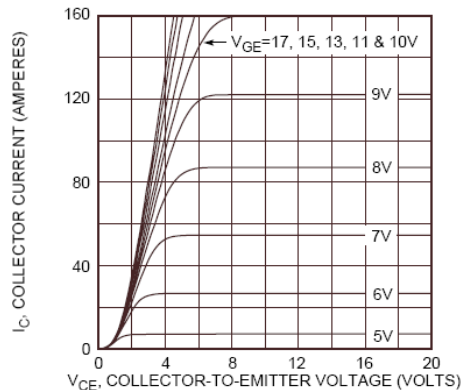

**Figure 2, Typical Output Characteristics ( $T_J = 150^\circ\text{C}$ )**

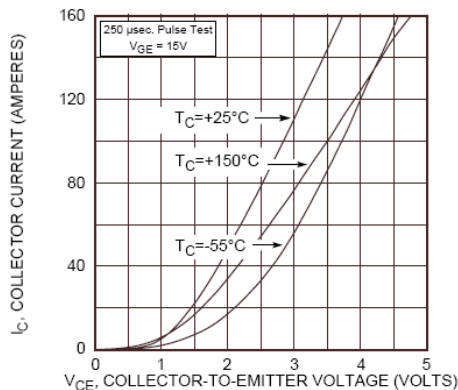

**Figure 3, Typical Output Characteristics @  $V_{GE} = 15\text{V}$**

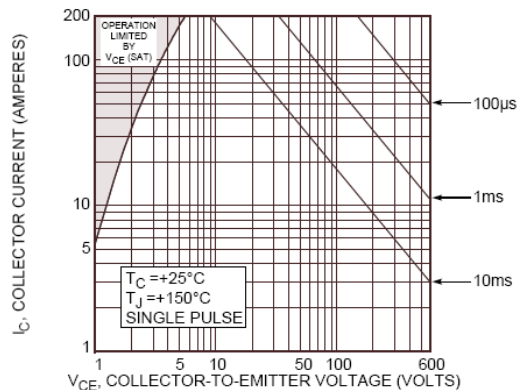

**Figure 4, Maximum Forward Safe Operating Area**

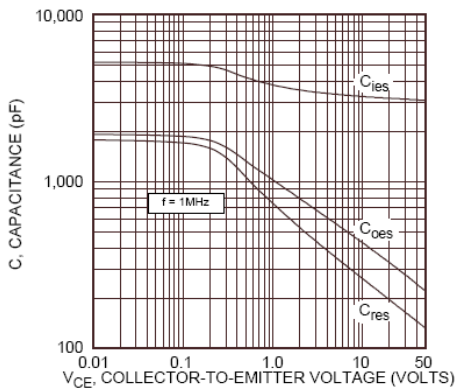

**Figure 5, Typical Capacitance vs Collector-To-Emitter Voltage**

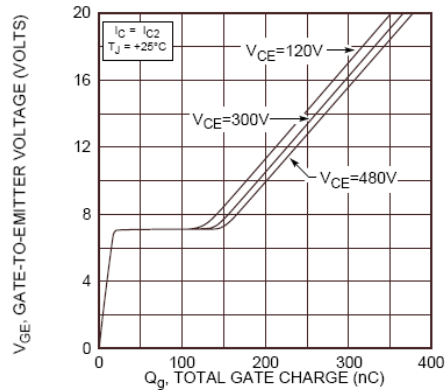

**Figure 6, Gate Charges vs Gate-To-Emitter Voltage**

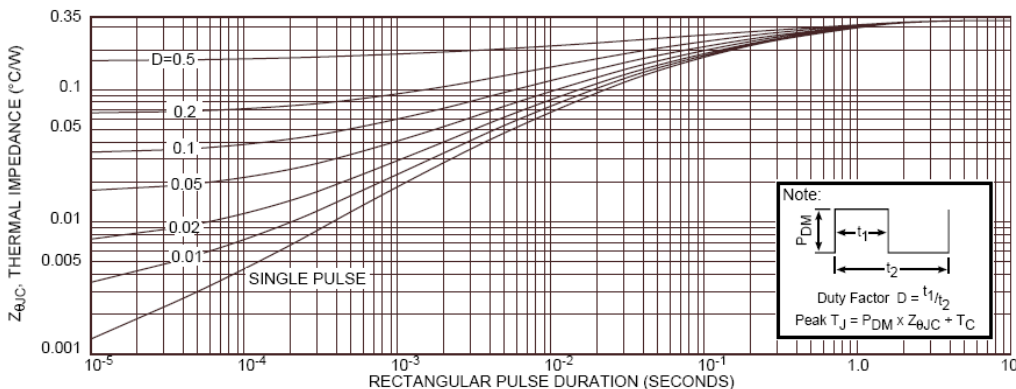

**Figure 7, Maximum Effective Transient Thermal Impedance, Junction-To-Case vs Pulse Duration**

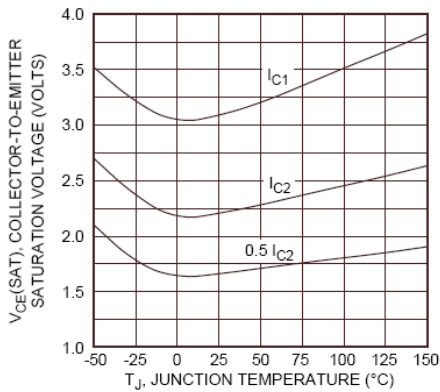

Figure 8, Typical  $V_{CE(SAT)}$  Voltage vs Junction Temperature

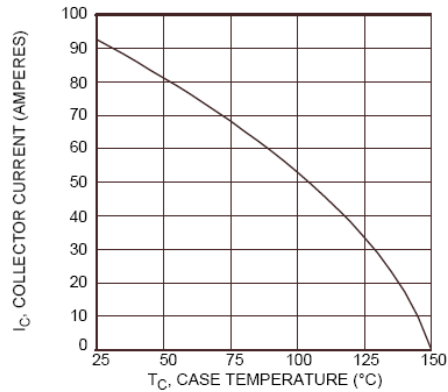

Figure 9, Maximum Collector Current vs Case Temperature

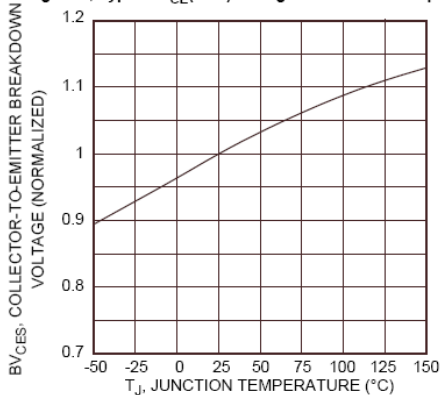

Figure 10, Breakdown Voltage vs Junction Temperature

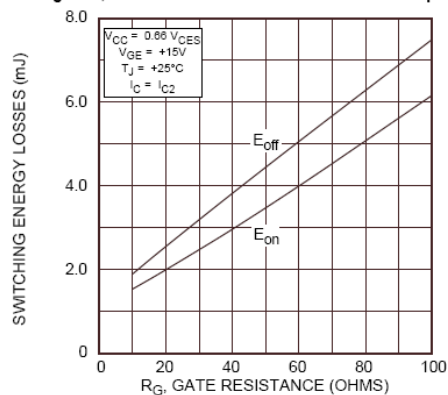

Figure 11, Typical Switching Energy Losses vs Gate Resistance

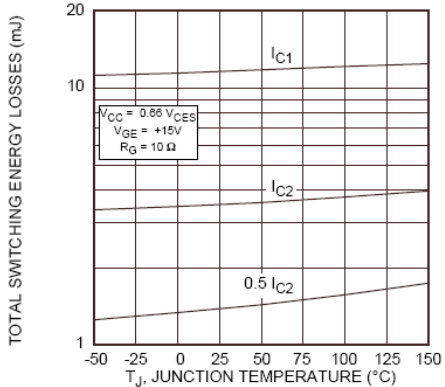

Figure 12, Typical Switching Energy Losses vs. Junction Temperature

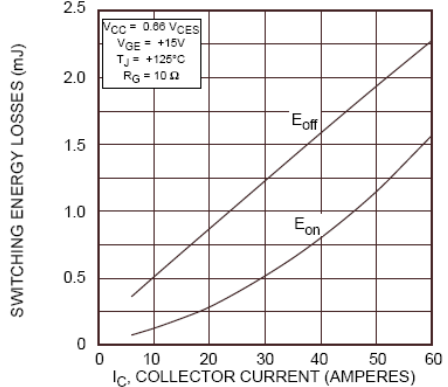

Figure 13, Typical Switching Energy Losses vs Collector Current

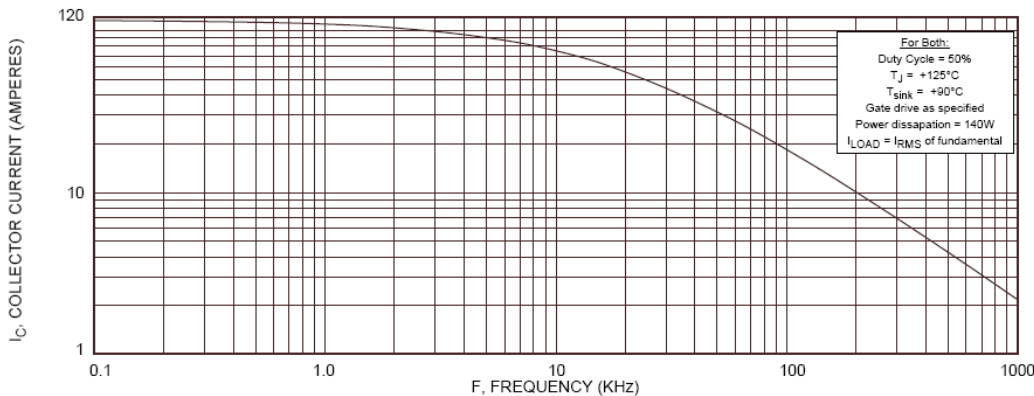

Figure 14, Typical Load Current vs Frequency

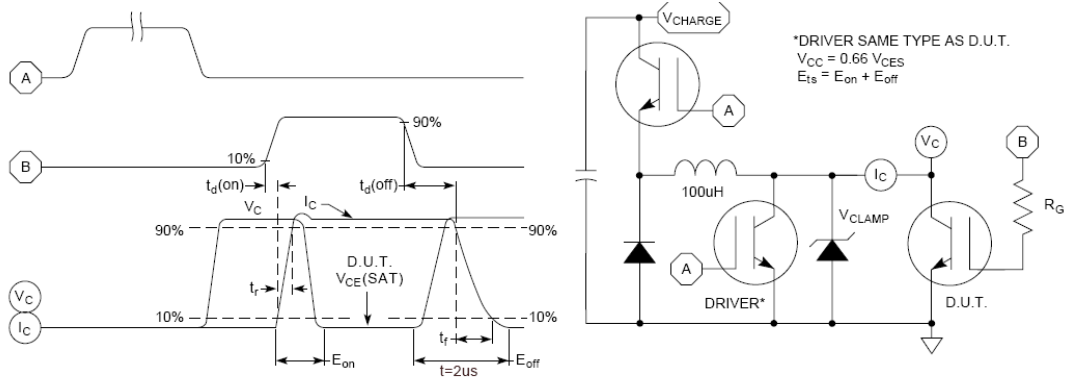

Figure 15, Switching Loss Test Circuit and Waveforms

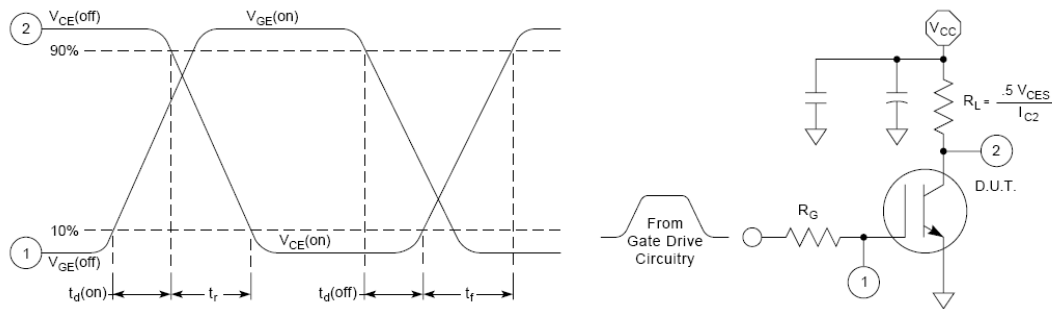

Figure 16, Resistive Switching Time Test Circuit and Waveforms

**Typical Diode Performance Curve**

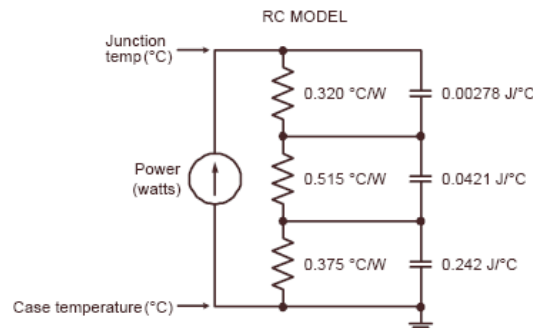
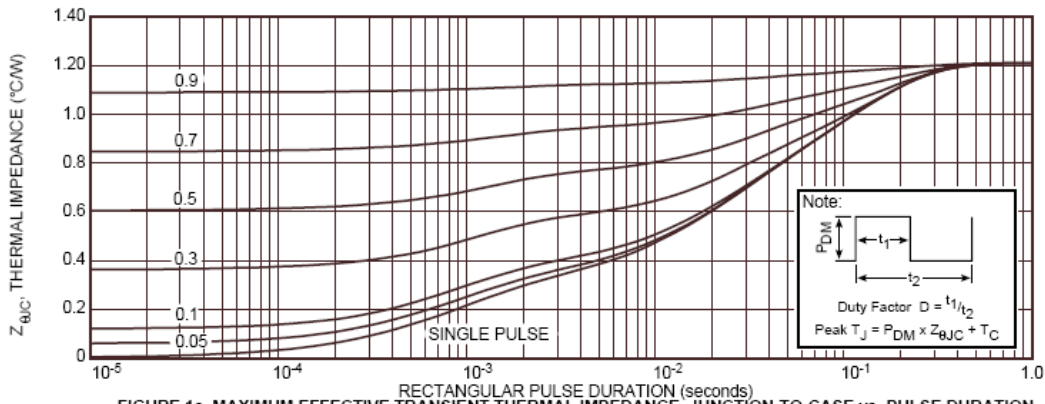

FIGURE 1b, TRANSIENT THERMAL IMPEDANCE MODEL

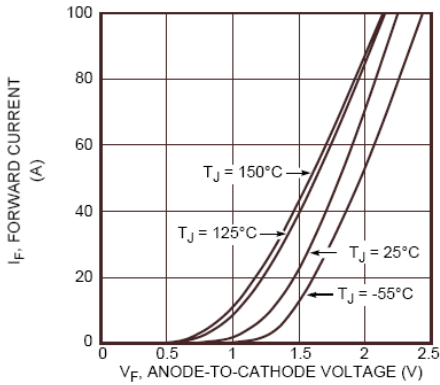

Figure 2. Forward Current vs. Forward Voltage

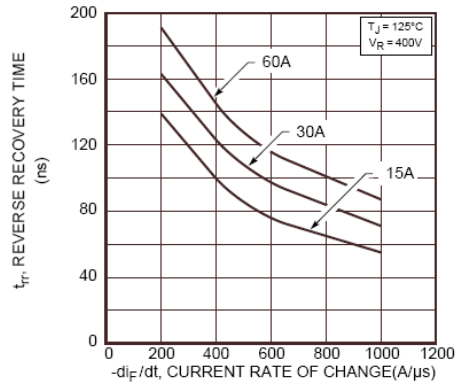

Figure 3. Reverse Recovery Time vs. Current Rate of Change

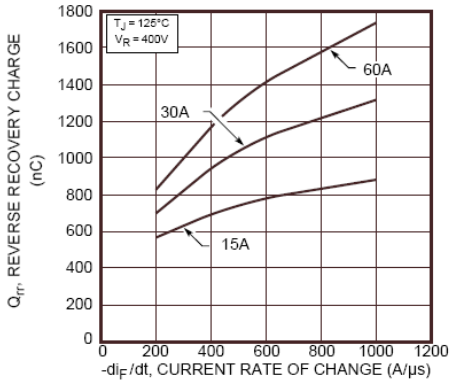

Figure 4. Reverse Recovery Charge vs. Current Rate of Change

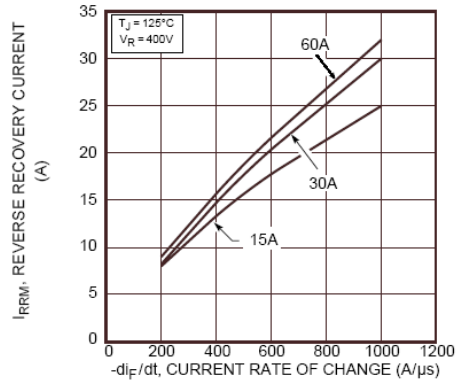

Figure 5. Reverse Recovery Current vs. Current Rate of Change

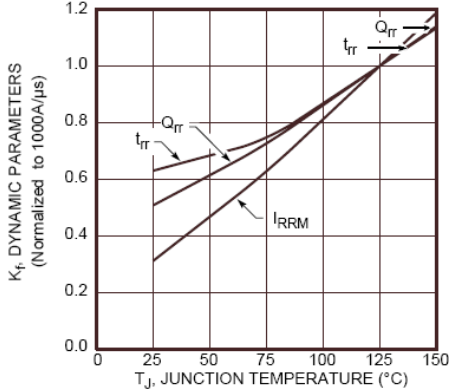

Figure 6. Dynamic Parameters vs. Junction Temperature

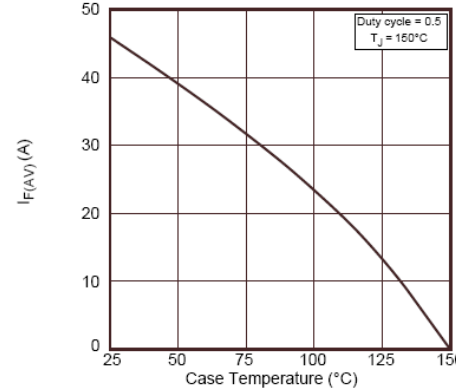

Figure 7. Maximum Average Forward Current vs. Case Temperature

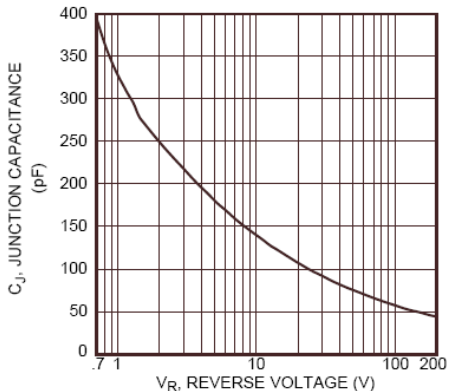

Figure 8. Junction Capacitance vs. Reverse Voltage

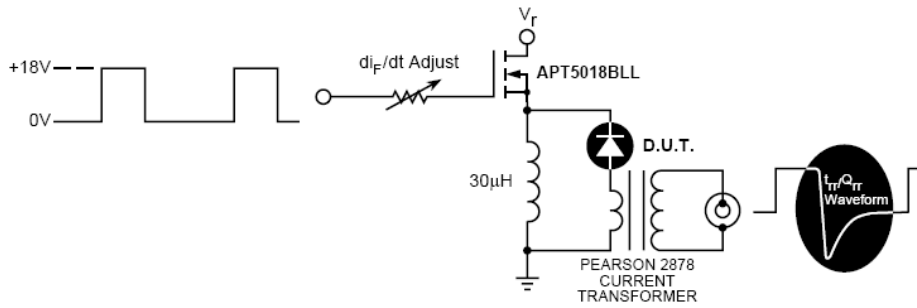

Figure 9. Diode Test Circuit

- ❶  $I_F$  - Forward Conduction Current
- ❷  $di_F/dt$  - Rate of Diode Current Change Through Zero Crossing.
- ❸  $I_{RRM}$  - Maximum Reverse Recovery Current.
- ❹  $t_{rr}$  - Reverse Recovery Time, measured from zero crossing where diode current goes from positive to negative, to the point at which the straight line through  $I_{RRM}$  and  $0.25 \cdot I_{RRM}$  passes through zero.
- ❺  $Q_{rr}$  - Area Under the Curve Defined by  $I_{RRM}$  and  $t_{rr}$ .

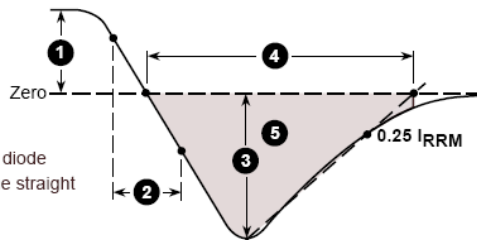
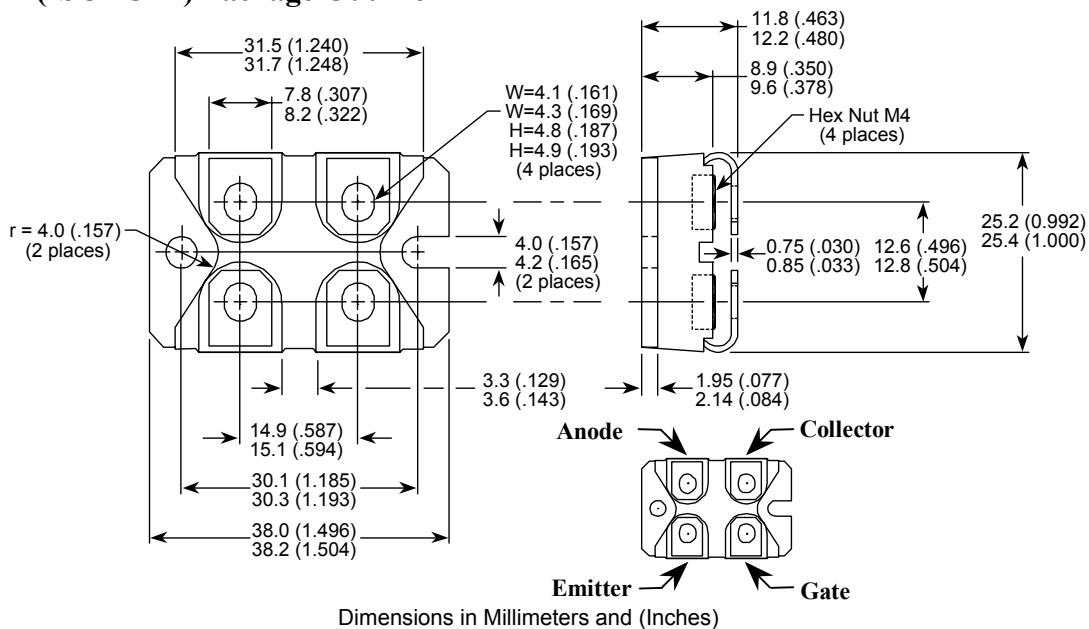

Figure 10. Diode Reverse Recovery Waveform and Definitions

**SOT-227 (ISOTOP®) Package Outline**



ISOTOP® is a Registered Trademark of SGS Thomson

APT reserves the right to change, without notice, the specifications and information contained herein

APT's products are covered by one or more of U.S. patents 4,895,810 5,045,903 5,089,434 5,182,234 5,019,522 5,262,336 6,503,786 5,256,583 4,748,103 5,283,202 5,231,474 5,434,095 5,528,058 and foreign patents. U.S. and Foreign patents pending. All Rights Reserved.