

*Phase leg
Series & SiC parallel diodes
Super Junction
MOSFET Power Module*

**$V_{DSS} = 800V$
 $R_{DSon} = 100m\Omega \text{ max @ } T_j = 25^\circ C$
 $I_D = 42A \text{ @ } T_c = 25^\circ C$**

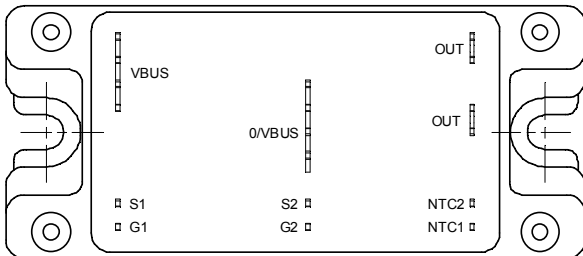
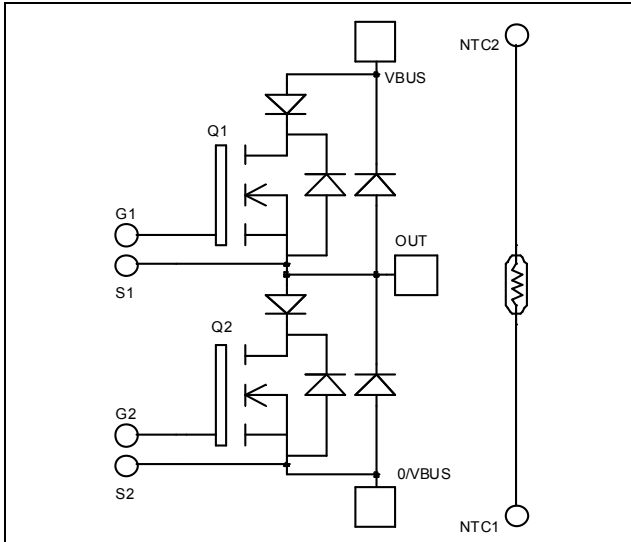

Application

- Motor control
- Switched Mode Power Supplies
- Uninterruptible Power Supplies

Features

- **COOLMOS** Power Semiconductors
 - Ultra low R_{DSon}
 - Low Miller capacitance
 - Ultra low gate charge
 - Avalanche energy rated
- **Parallel SiC Schottky Diode**
 - Zero reverse recovery
 - Zero forward recovery
 - Temperature Independent switching behavior
 - Positive temperature coefficient on VF
- Kelvin source for easy drive
- Very low stray inductance
 - Symmetrical design
 - Lead frames for power connections
- Internal thermistor for temperature monitoring
- High level of integration

Benefits

- Outstanding performance at high frequency operation
- Direct mounting to heatsink (isolated package)
- Low junction to case thermal resistance
- Solderable terminals both for power and signal for easy PCB mounting
- Low profile

Absolute maximum ratings

Symbol	Parameter	Max ratings	Unit
V_{DSS}	Drain - Source Breakdown Voltage	800	V
I_D	Continuous Drain Current	$T_c = 25^\circ C$	42
		$T_c = 80^\circ C$	32
I_{DM}	Pulsed Drain current	172	
V_{GS}	Gate - Source Voltage	± 30	V
R_{DSon}	Drain - Source ON Resistance	100	$m\Omega$
P_D	Maximum Power Dissipation	$T_c = 25^\circ C$	416
I_{AR}	Avalanche current (repetitive and non repetitive)	24	A
E_{AR}	Repetitive Avalanche Energy	0.5	mJ
E_{AS}	Single Pulse Avalanche Energy	670	

CAUTION: These Devices are sensitive to Electrostatic Discharge. Proper Handling Procedures Should Be Followed.

All ratings @ $T_j = 25^\circ\text{C}$ unless otherwise specified

Electrical Characteristics

Symbol	Characteristic	Test Conditions	Min	Typ	Max	Unit
BV_{DSS}	Drain - Source Breakdown Voltage	$V_{GS} = 0V, I_D = 750\mu A$	800			V
I_{DSS}	Zero Gate Voltage Drain Current	$V_{GS} = 0V, V_{DS} = 800V, T_j = 25^\circ\text{C}$			75	μA
		$V_{GS} = 0V, V_{DS} = 800V, T_j = 125^\circ\text{C}$			750	
$R_{DS(on)}$	Drain - Source on Resistance	$V_{GS} = 10V, I_D = 21A$			100	$m\Omega$
$V_{GS(th)}$	Gate Threshold Voltage	$V_{GS} = V_{DS}, I_D = 3mA$	2.1	3	3.9	V
I_{GSS}	Gate - Source Leakage Current	$V_{GS} = \pm 20V, V_{DS} = 0V$			± 175	nA

Dynamic Characteristics

Symbol	Characteristic	Test Conditions	Min	Typ	Max	Unit
C_{iss}	Input Capacitance	$V_{GS} = 0V$		6761		pF
C_{oss}	Output Capacitance	$V_{DS} = 25V$		3137		
C_{rss}	Reverse Transfer Capacitance	$f = 1MHz$		161		
Q_g	Total gate Charge	$V_{GS} = 10V$		273		nC
Q_{gs}	Gate - Source Charge	$V_{Bus} = 400V$		36		
Q_{gd}	Gate - Drain Charge	$I_D = 42A$		138		
$T_{d(on)}$	Turn-on Delay Time	Inductive switching @ 125°C $V_{GS} = 15V$ $V_{Bus} = 533V$ $I_D = 42A$ $R_G = 1.8\Omega$		10		ns
T_r	Rise Time			13		
$T_{d(off)}$	Turn-off Delay Time			83		
T_f	Fall Time			35		
E_{on}	Turn-on Switching Energy	Inductive switching @ 25°C $V_{GS} = 15V, V_{Bus} = 533V$ $I_D = 42A, R_G = 1.8\Omega$		437		μJ
E_{off}	Turn-off Switching Energy ❶			417		
E_{on}	Turn-on Switching Energy	Inductive switching @ 125°C $V_{GS} = 15V, V_{Bus} = 533V$ $I_D = 42A, R_G = 1.8\Omega$		765		μJ
E_{off}	Turn-off Switching Energy ❶			513		

❶ In accordance with JEDEC standard JESD24-1.

Series diode ratings and characteristics

Symbol	Characteristic	Test Conditions	Min	Typ	Max	Unit
$I_{F(AV)}$	Maximum Average Forward Current	50% duty cycle, $T_c = 85^\circ\text{C}$		30		A
V_F	Diode Forward Voltage	$I_F = 30A$			1.15	V
		$I_F = 60A$		1.05		
		$I_F = 30A, T_j = 125^\circ\text{C}$			1	
t_{rr}	Reverse Recovery Time	$I_F = 30A, V_R = 133V, di/dt = 200A/\mu s, T_j = 25^\circ\text{C}$		24		ns
		$T_j = 125^\circ\text{C}$		48		
Q_{rr}	Reverse Recovery Charge	$I_F = 30A, V_R = 133V, di/dt = 200A/\mu s, T_j = 25^\circ\text{C}$		33		nC
		$T_j = 125^\circ\text{C}$		150		

Parallel diode ratings and characteristics

Symbol	Characteristic	Test Conditions		Min	Typ	Max	Unit
I _{F(AV)}	Maximum Average Forward Current	50% duty cycle	T _c = 125°C		20		A
V _F	Diode Forward Voltage	I _F = 20A	T _j = 25°C		1.6	1.8	V
			T _j = 175°C		2.6	3.0	
Q _C	Total Capacitive Charge	I _F = 20A, V _R = 600V di/dt = 1200A/μs			56		nC
Q	Total Capacitance	f = 1MHz, V _R = 200V			180		pF
		f = 1MHz, V _R = 400V			132		

Thermal and package characteristics

Symbol	Characteristic			Min	Typ	Max	Unit
R _{thJC}	Junction to Case	Transistor				0.3	°C/W
		Series diode				1.2	
		Parallel diode				0.8	
V _{ISOL}	RMS Isolation Voltage, any terminal to case t = 1 min, I _{isol} < 1mA, 50/60Hz			2500			V
T _J	Operating junction temperature range			-40		150	°C
T _{STG}	Storage Temperature Range			-40		125	
T _C	Operating Case Temperature			-40		100	
Torque	Mounting torque	To Heatsink	M5			4.7	N.m
Wt	Package Weight					160	g

Temperature sensor NTC

Symbol	Characteristic	Min	Typ	Max	Unit
R ₂₅	Resistance @ 25°C		68		kΩ
B _{25/85}	T ₂₅ = 298.16 K		4080		K

$$R_T = \frac{R_{25}}{\exp \left[B_{25/85} \left(\frac{1}{T_{25}} - \frac{1}{T} \right) \right]}$$

T: Thermistor temperature
R_T: Thermistor value at T

Package outline

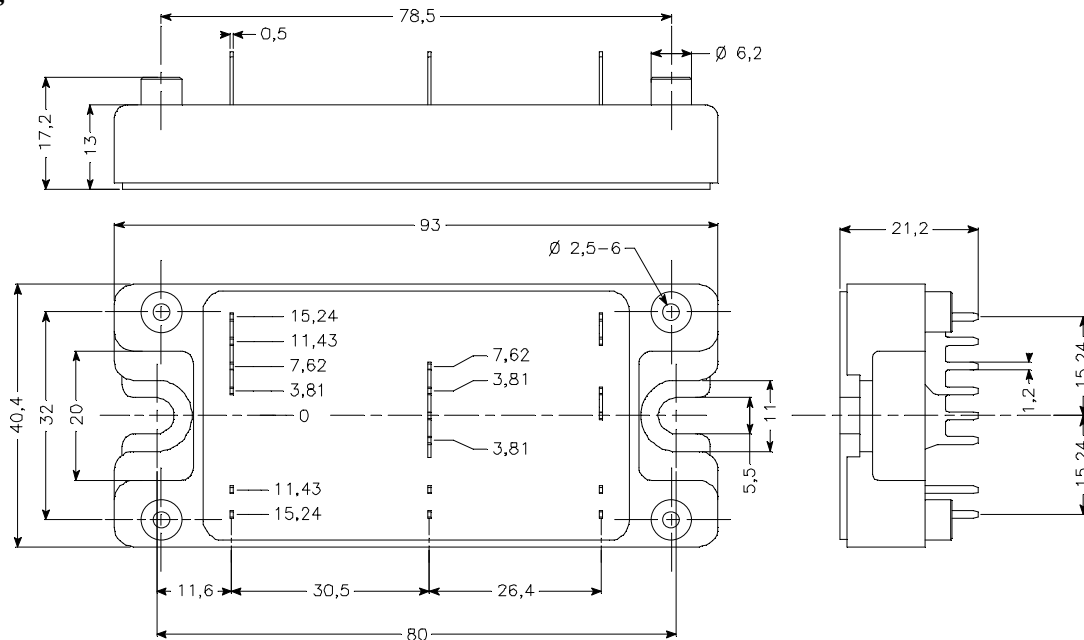

Typical CoolMOS Performance Curve

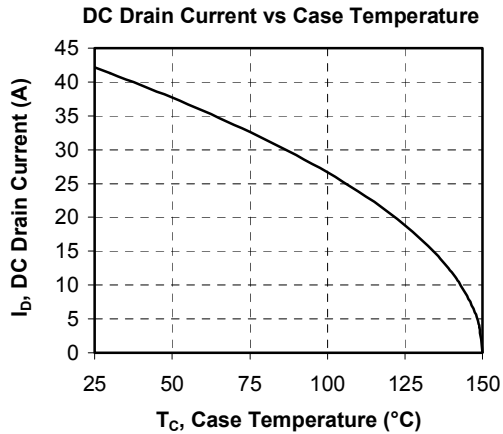
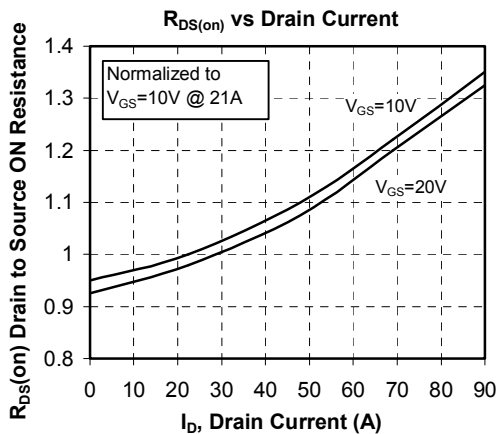
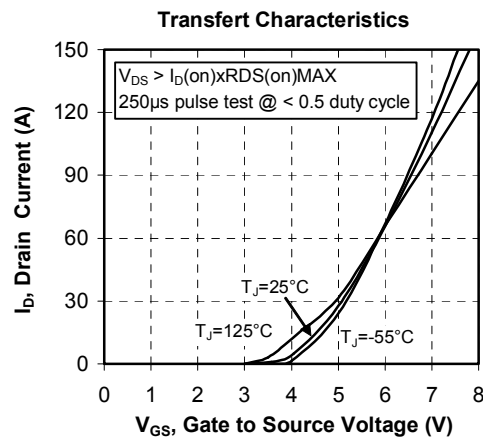
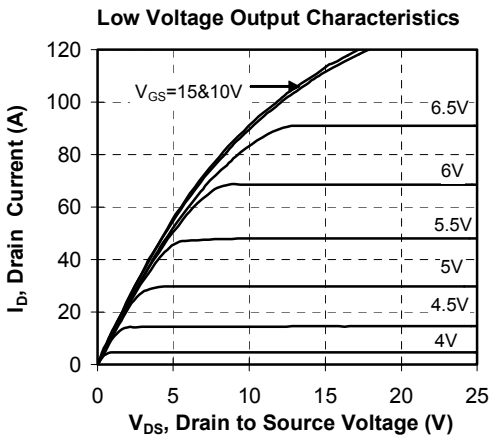
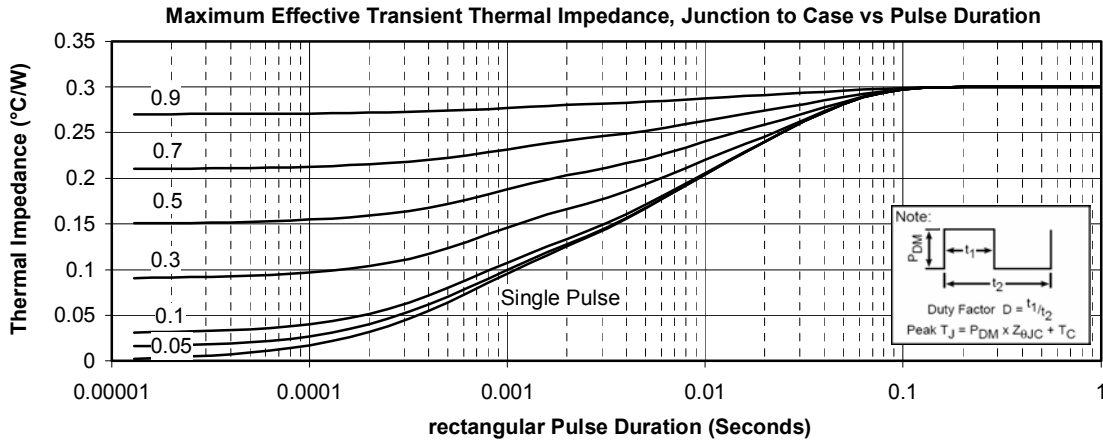

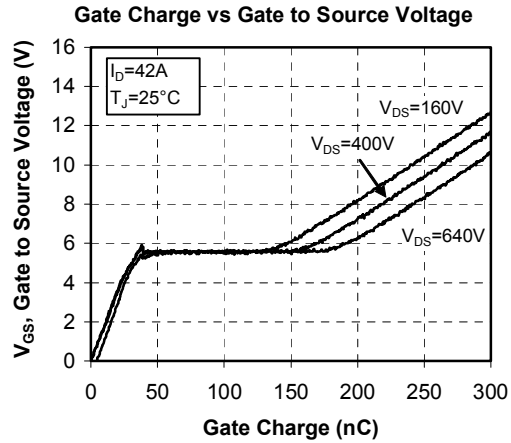
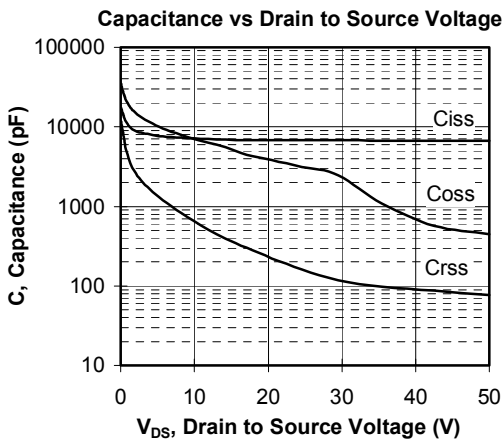
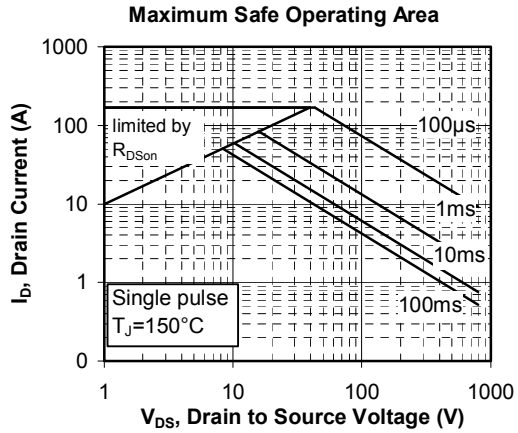
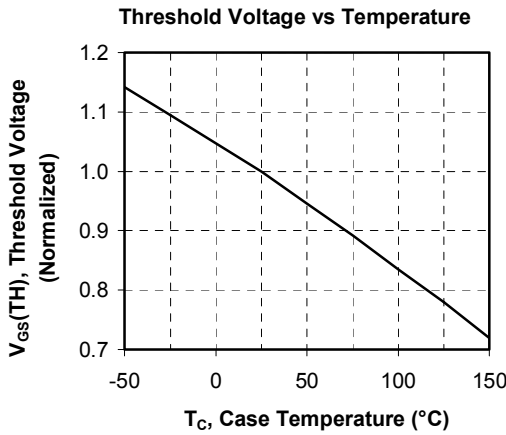
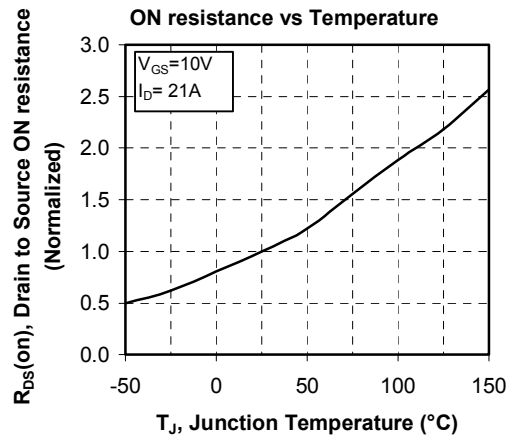
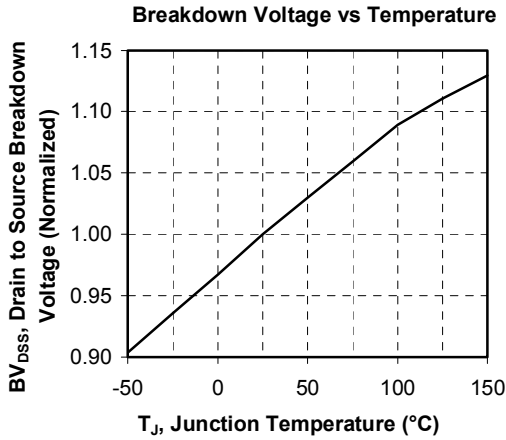

Delay Times vs Current

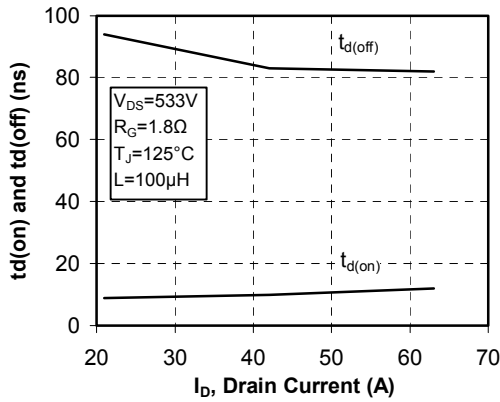

Rise and Fall times vs Current

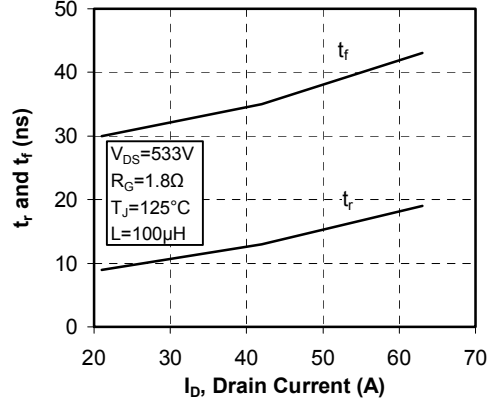

Switching Energy vs Current

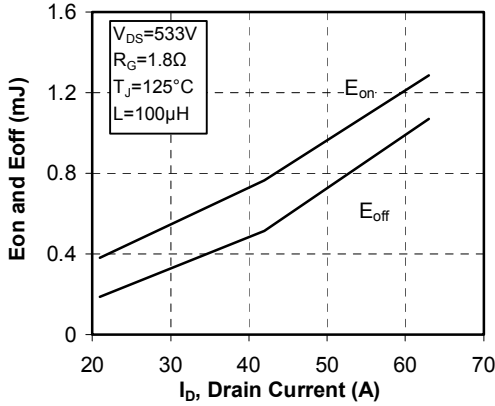

Switching Energy vs Gate Resistance

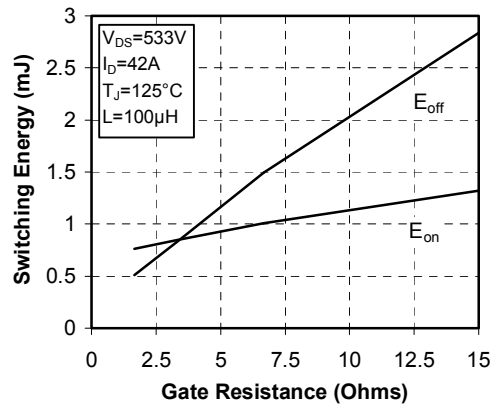

Operating Frequency vs Drain Current

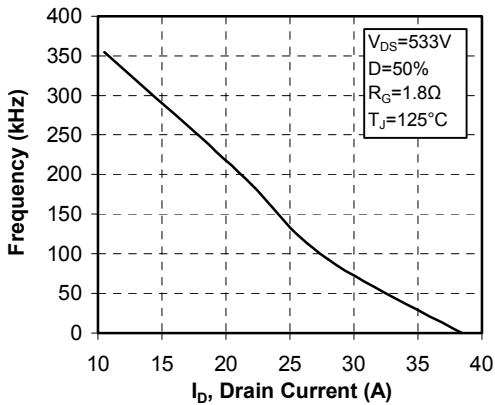

Source to Drain Diode Forward Voltage

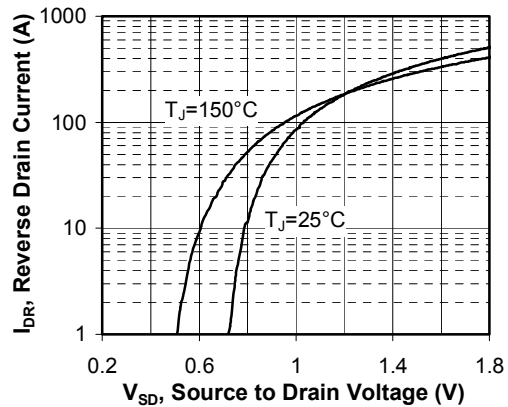

Typical SiC Diode Performance Curve

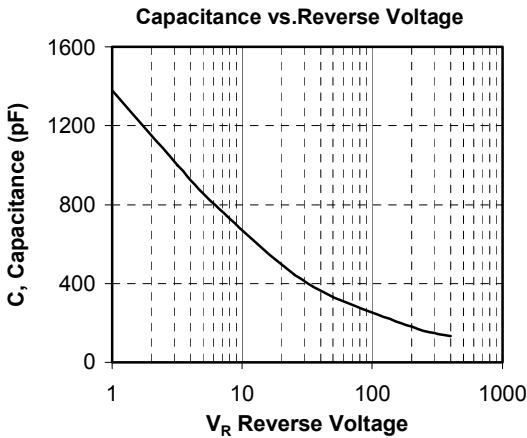
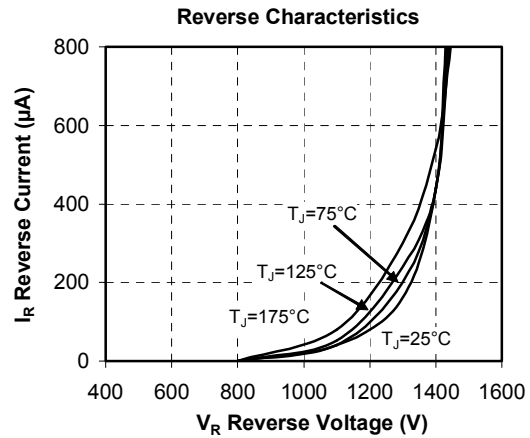
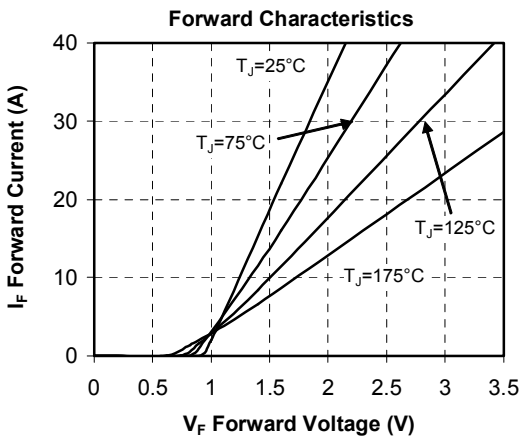
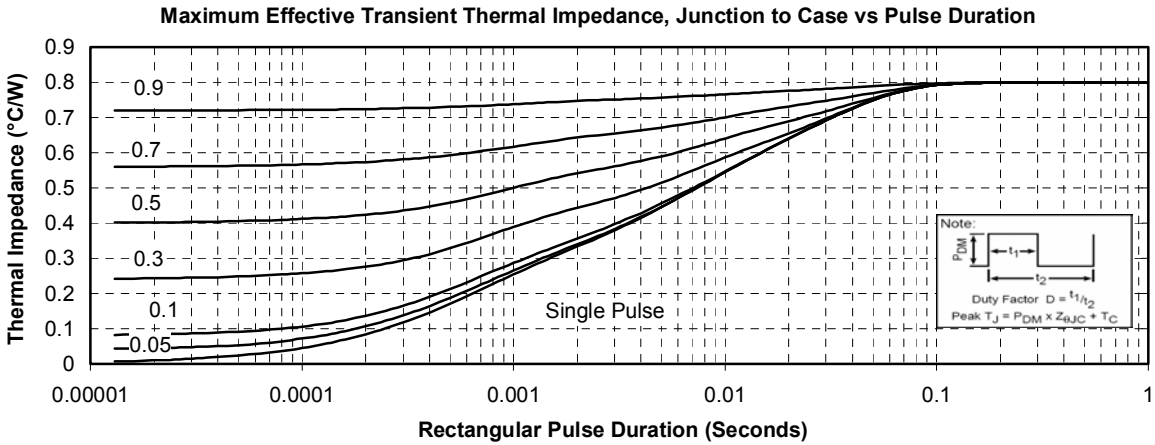

“COOLMOS™” comprise a new family of transistors developed by Infineon Technologies AG. “COOLMOS” is a trademark of Infineon Technologies AG”.

APT reserves the right to change, without notice, the specifications and information contained herein

APT's products are covered by one or more of U.S patents 4,895,810 5,045,903 5,089,434 5,182,234 5,019,522 5,262,336 6,503,786 5,256,583 4,748,103 5,283,202 5,231,474 5,434,095 5,528,058 and foreign patents. U.S and Foreign patents pending. All Rights Reserved.