

# Industrial DC/DC CONVERTER CGDI Standard Input TETHYS : 30W POWER

Industrial  
Grade ■



## 2:1 Standard Input Configurable Multiple Outputs Metallic case - 1.500 VDC Isolation



- Highly configurable DC/DC converter
- Up to 6 outputs and 3 independent line regulations
- Low profile : 0,33 " ( 8.5mm)
- Nominal Power of 30 W without derating
- Wide temperature range : -40°C/+95°C case
- Galvanic isolation 1.500 VDC
- Integrated LC EMI filter
- Permanent short circuit protection
- External trim and sense adjustment : +/-5%
- Inhibit function
- RoHS process

### 1-General

The TETHYS 30W series is a full family of highly configurable DC/DC low profile power module designed for direct implementation on high density printed circuit boards in distributed power architecture and are particularly suitable for mobile or ground fixed application in transportation, industrial and telecommunication areas. This module uses a high frequency fixed switching technic at 480 KHz providing excellent reliability, low noise characteristics and low profile package. This model is available with nominal input voltages as 24 volts in range of 18-36 volts. The serie includes thousands of output configuration from single, bi up to six possible output voltages in choices of 3,3, 5, 12, 15, 24 volts with trim and sense functions for output voltage adjustment.

No external heatsink is required for the for CGDI serie to supply 30W output power over the full temperature range. All the modules are designed with LC network filters to minimize reflected input current ripple and output voltage ripple .

The modules include a soft-start, an input undervoltage lock-out, a permanent short circuit protection an output overvoltage protection and a thermal protection to ensure efficient module protections.

The soft-start allows current limitation and eliminates inrush current during start-up. The short circuit protection completely protects the module against short-circuits of any duration by a shut-down and restores to normal when the overload is removed. The thermal protection is adjusted to 110°C and protects the module against overheat.

The inhibit function is commanded with a low logic level and disables the module for applications requiring on/off operations.

The design has been carried out with surface mount components and is manufactured in a fully automated process to guarantee high quality. Each modules are tested with a GAIA Converter automated test equipment.

5

### 2-Product Selection

Multiple output model : CGDI -  input -  output -  output -  output

Input Voltage Range	Output
Permanent	
I : 18-36 VDC	3 : 3.3 VDC
	5 : 5 VDC
	5B : +/-5VDC
	12 : 12 VDC
	12B : +/-12VDC
	15 : 15 VDC
	15B : +/-15VDC
	24 : 24 VDC
	24B : +/-24VDC

## 2- Product Selection (continued)

Single line model	: CGDI-	<input type="checkbox"/>	-	<input type="checkbox"/>	-	0	-	0	>	30 W first line output : primary output
Dual line model	: CGDI-	<input type="checkbox"/>	-	<input type="checkbox"/>	-	0	-	<input type="checkbox"/>	>	20 W first line output : primary output > 10 W second line output : secondary output
Triple line model	: CGDI-	<input type="checkbox"/>	-	<input type="checkbox"/>	-	<input type="checkbox"/>	-	<input type="checkbox"/>	>	10 W on each line output : primary and secondary outputs

First line output functions :	Trim function at +/- 5% Sense function at +/- 5% Tight regulation below 1% Indefinite short circuit protection
Secondary line output functions :	Independant regulation from primary output Indefinite short circuit protection

Input Voltage Range	
Designation	Permanent
I	18-36 VDC

Output Voltage	
Designation	Output Voltage
3	3.3 VDC
5	5 VDC
5B	+/-5VDC
12	12 VDC
12B	+/-12VDC
15	15 VDC
15B	+/-15VDC
24	24 VDC

5

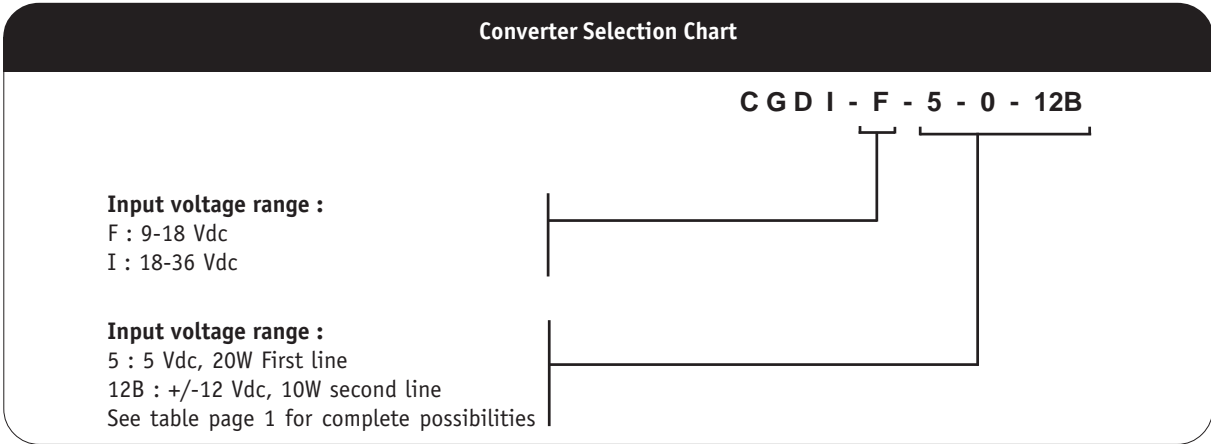

## 3- Electrical Specifications

Data are valid at +25°C, unless otherwise specified.

Parameter	Conditions	Limit or typical	Units	CGDI-I
<b>Input</b>				
Nominal input voltage	Full temperature range	Nominal	VDC	24
Permanent input voltage range (Ui)	Full temperature range	Min. - Max.	VDC	18- 36
Undervoltage lock-out (UVLO)	Threshold	Minimum	VDC	16
		Maximum	VDC	17,5
Start up time	Ui nominal Nominal output Full load : resistive	Maximum	ms	40
Reflected ripple current	Ui nominal, full load at switching freq. BW = 20MHz	Maximum	mApp	50
Input current in short circuit mode (Average)	Ui nominal Short-circuit	Maximum	mA	60
No load input current	Ui nominal No load	Maximum	mA	60
<b>Primary Output</b>				
Output voltage *	Ui min. to max. 75% load	Nominal	VDC	3,3V , 5V , 12V , 15V or 24V <i>Consult factory for other outputs</i>
Set Point accuracy + Line regulation + Load regulation	Ambient temperature : +25°C Ui min. to max. 25% to full load	Maximum	%	+/- 1
Output power	Full temperature range Ui min. to max.	Maximum	W	10, 20 or 30 (limited to respectively 2A, 4A or 6A max)
Ripple output voltage **	Ui nominal	Maximum	mVpp	40
	3,3V and 5V output	Maximum	mVpp	50
	12V output	Maximum	mVpp	60
	15V and 24V output	Maximum	mVpp	60
Trim function	Ui nominal	Maximum	%	+ 5
		Minimum	%	- 5
Sense function	Ui nominal	Maximum	%	+ 5
		Minimum	%	- 5
<b>Secondary Output</b>				
Output voltage *	Ui min. to max. 75% load	Nominal	VDC	3,3V , 5V , 12V , 15V or 24V +/- 5V , +/- 12V , +/- 15V or +/- 24V <i>Consult factory for other outputs</i>
Set point accuracy	Ambient temperature : +25°C Ui nominal, 75% load	Maximum	%	+/- 2
Output power	Full temperature range Ui min. to max.	Maximum	W	10 or 20 (limited to respectively 2A or 4A max)
Ripple output voltage **	Ui nominal	Maximum	mVpp	50
	3,3V, 5V and +/-5V output	Maximum	mVpp	100
	12V and +/-12V output	Maximum	mVpp	150
	15V and +/-15V output	Maximum	mVpp	150
	24V and +/-24V output	Maximum	mVpp	150
Line regulation	Ui min. to max. Full load	Maximum	%	+/- 1
Load regulation ***	Ui nominal 25% to full load	Maximum	%	+/- 2,5

Note \* : For proper operation the CGDI module requires to install a 22µF chemical or tantalum capacitance across output terminals.

Note \*\* : The ripple output voltage is the periodic AC component imposed on the output voltage, an aperiodic and random component (noise) has also to be considered. This noise can be reduced by adding an external capacitor (typically 10nF/rated voltage depending on isolation requirement) connected between the pin Gi and the pin Go of the converter. This capacitor should be layed-out as close as possible from the converter.

Note \*\*\* : For load regulation characteristics from 0% to full load, please contact factory.

## 4- Switching Frequency

Parameter	Conditions	Limit or typical	Specifications
Switching frequency	Full temperature range Ui min. to max. No load to full load	Nominal, fixed	18-36 VDC input : 480 KHz

## 5- Isolation

Parameter	Conditions	Limit or typical	Specifications
Electric strength test voltage (basic version)	Input to output	Minimum	1.500 VDC / 1 min
Electric strength test voltage between outputs (for outputs of the same line of regulation)	Output to output	Minimum	No isolation
Electric strength test voltage between outputs (for outputs of different line of regulation)	Output to output	Minimum	500 VDC / / 1 min.
Isolation resistance	500 VDC	Minimum	100 MOhm

## 6- Protection Functions

Characteristics	Protection Device	Recovery	Limit or typical	Specifications
Output short circuit protection (SCP)	Hiccup circuitry with auto-recovery	Automatic recovery	Permanent	See section 11
Output overvoltage protection (OVP)	Zener clamp	/	Maximum Maximum Maximum Maximum	For 3.3v : 4v For 5v : 6v For 12v : 14v For 15v : 17v
over temperature protection (OTP)	Thermal device with hysteresis cycle	Automatic recovery	Nominal	115°C

## 7- Reliability Data

Characteristics	Conditions	Temperature	Specifications
Mean Time Between Failure (MTBF) According to MIL-HDBK-217F	Ground fixed (Gf)	Case at 40°C Case at 70°C	480.000 Hrs 190.000 Hrs
	Ground mobile (Gm)	Case at 40°C Case at 70°C	Consult factory
Mean Time Between Failure (MTBF) According to IEC-62380-TR	Telecom switchers	/	Consult factory

## 8- Electromagnetic Interference

Electromagnetic interference requirements according to EN55022 class A and class B can be easily achieved as indicated in the following table :

Electromagnetic Interference according to EN55022			
Conducted noise emission	Configuration	With common mode capacitor $C_c = 10\text{nF}$ and input capacitor $C_i$	With common mode capacitor $C_c = 10\text{nF}$ and external filter
	Models	18-36V input models	Class A, $C_i = 4.7\mu\text{F} / 50\text{V}$ tantalum
Radiated noise emission	Configuration	With common mode capacitor $C_c = 10\text{nF}$	
	Models	All models	Class B

### 8-1 Module Compliance with EN 55022 Class B Standard

To meet EN55022 Class B requirements, Gaia Converter recommends the use of an external front filter (see EN55022 ClassB EMI Filter Design Note) together with a common mode noise capacitance  $C_c$  (10nF/rated voltage depending on isolation requirement) connected between  $G_{in}$  and  $G_{out}$ .

This common mode noise capacitance  $C_c$  should be laid-out as close as possible from the DC/DC converter. The typical schematic hereafter describes the Tethys used in a 4 outputs configuration (example 5V/2A, 3.3V/ 2A and +/-15V) with front filter, common mode noise  $C_c$  and output capacitance to reduce output ripple voltage.

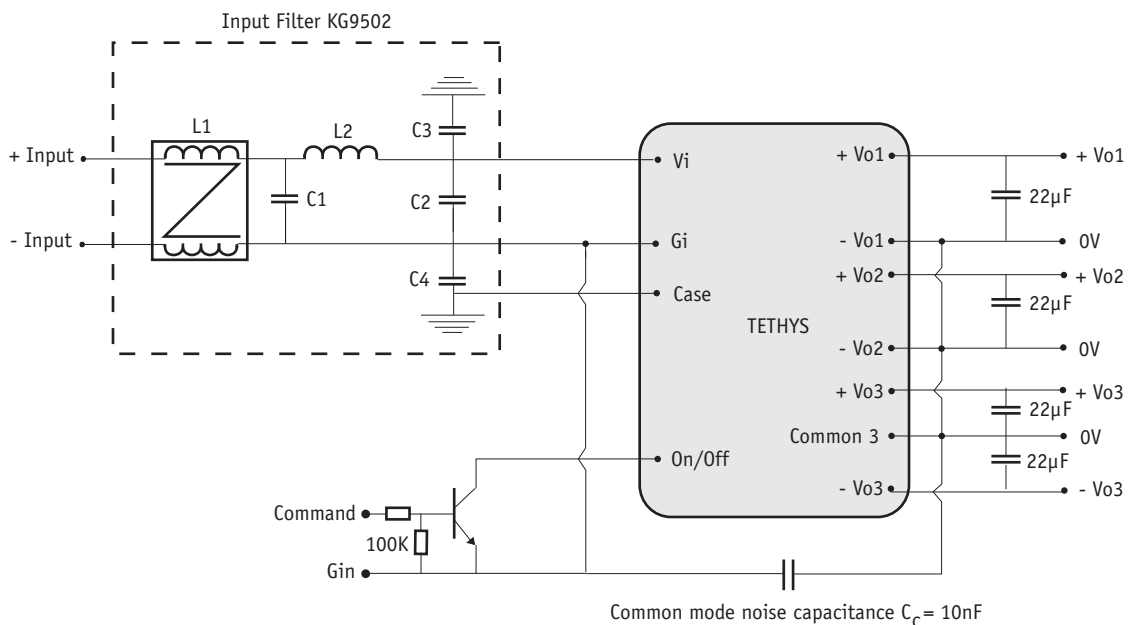

## 9- Thermal Characteristics

Characteristics	Conditions	Limit or typical	Performances
Operating ambient temperature range at full load	Ambient temperature *	Minimum Maximum	- 40°C + 71°C
Operating case temperature range at full load	Case temperature	Minimum Maximum	- 40°C +95°C
Storage temperature range	Non functioning	Minimum Maximum	- 40°C + 105°C
Thermal resistance	Rth case to ambient in free air natural convection	Typical	4°C /W

Note \*: The upper temperature range depends on configuration, the user must assure a max. case temperature of + 95°C.

The CGDI series operating **case** temperature must not exceed 95°C. The maximum **ambient** temperature admissible for the DC/DC converter corresponding to the maximum operating case temperature of 95°C depends on the ambient airflow, the mounting/orientation, the cooling features and the power dissipated.

To calculate a maximum admissible ambient temperature the following method can be used. Knowing the maximum case temperature Tcase = 95°C of the module, the power used Pout and the efficiency η :

- determine the power dissipated by the module P<sub>diss</sub> that should be evacuated :

$$P_{diss} = P_{out}(1/\eta - 1)$$

- determine the maximum ambient temperature :

$$T_a = 95^\circ\text{C} - R_{th} \times P_{diss}$$

where **Rth** is the thermal resistance from the case to ambient.

The previous thermal calculation shows two areas of operation :

- a normal operation area in a free natural ambient convection (grey area in this following graph),
- an area with cooling features (air flow or heatsink) ensuring a maximum case temperature below the maximum operating case temperature of 95°C (white area in the following graph).

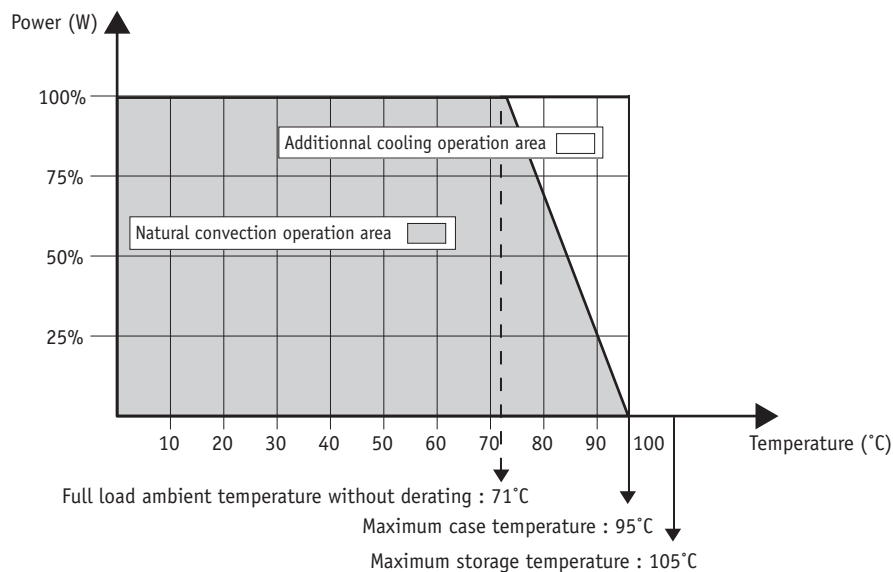

## 10- Environmental Qualifications

The modules have been subjected to the following environmental qualifications.

Characteristics	Conditions	Severity	Test procedure
<b>Climatic Qualifications</b>			
Life at high temperature	Duration Temperature Status of unit	1.000 Hrs 95°C case unit operating	IEC 68-2-2
Humidity steady	Damp heat Temperature Duration Status of unit	93 % relative humidity 40°C 56 days unit not operating	IEC 68-2-3 Test Ca
Temperature cycling	Number of cycles Temperature change Transfert time Steady state time Status of unit	200 -40°C / +71°C 40 min. 20 min. unit not operating	IEC 68-2-14 Test N
Temperature shock	Number of shocks Temperature change Transfert time Steady state time Status of unit	50 -40°C / +105°C 10 sec. 20 min. unit not operating	IEC 68-2-14 Test Na
<b>Mechanical Qualifications</b>			
Vibration (Sinusoidal)	Number of cycles Frequency : amplitude Frequency : acceleration Amplitude /acceleration Duration Status of unit	10 cycles in each axis 10 to 60 Hz / 0.7 mm 60 to 2000 Hz / 10 g 0.7 mm/10 g 2h 30 min. per axis unit not operating	IEC 68-2-6 Test Fc
Shock (Half sinus)	Number of shocks Peak acceleration Duration Shock form Status of unit	3 shocks in each axis 100 g 6 ms 1/2 sinusoidal unit not operating	IEC 68-2-27 Test Ea
Bump (Half sinus)	Number of bumps Peak acceleration Duration Status of unit	2000 bumps in each axis 25 g 6 ms unit not operating	IEC 68-2-29 Test Eb
<b>Electrical Immunity Qualifications</b>			
Electrical discharge susceptibility	Number of discharges Air discharge level Contact discharge level Air discharge level Contact discharge level	10 positive & 10 negative discharges 4 kV : sanction A 2 Kk : sanction A 8 Kk : sanction B 4 kV : sanction B	EN55082-2 with : EN61000-4-2 IEC 801-2
Electrical field susceptibility	Antenna position Electromagnetic field Wave form signal Frequency range	at 1 m 10 V/m AM 80%, 1 kHz 26 MHz to 1 GHz	EN55082-2 with : EN61000-4-3 IEC801-3
Electrical fast transient susceptibility	Burst form Wave form signal Impedance Level 1 Level 3	5/50 ns 5 kHz with 15 ms burst duration period 300 ms 50 Ohm 0,5 kV : sanction A 2 kV : sanction B	EN55082-2 with : EN61000-4-4 IEC801-4

## 11- Description of Protections

### 11-1 Input Undervoltage Lock-out (UVLO)

The input undervoltage lock-out protection device turns-on and turns-off the output voltage when the input bus voltage reaches the undervoltage lock-out threshold. There is no hysteresis cycle at turn-on and turn-off.

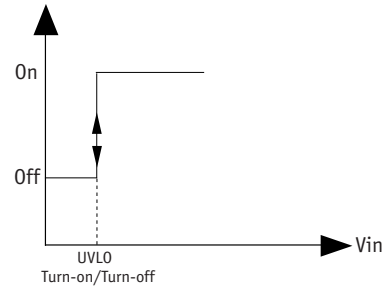

### 11-2 Output Short Circuit Protection (SCP)

The short circuit protection device protects the module against short circuits of any duration and restores the module to normal operation when the short circuit is removed. It operates in «hiccup» mode by testing periodically if an overload is applied (typically every 200ms recovery time). The overload detection threshold is typically 200% of maximum current with a detection time lower than 5ms.

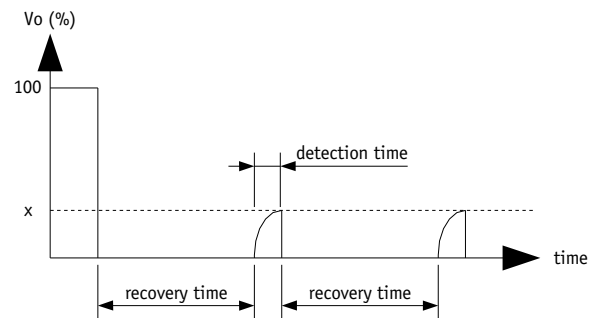

### 11-3 Output Overvoltage Protection (OVP)

The output overvoltage protection device protects external components against high voltage or possible overvoltages which can be supplied by the module (i.e in case of internal failure). It consists of a zener diode clamping the output voltage; under worst case conditions this zener diode will short-circuit.

The output voltage protection is not designed to withstand externally applied output overvoltages to protect the module itself.

### 11-4 Over Temperature Protection (OTP)

A thermal protection device adjusted at 115°C (+/-5%) internal temperature with 10°C hysteresis cycle will inhibit the module as long as the overheat is present and restores to normal operation automatically when overheat is removed. The efficiency of the OTP function is warranty with the module mounted on a heatsink.

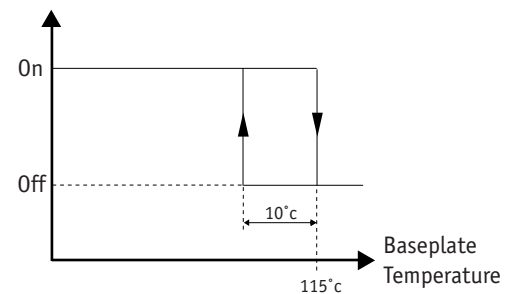



## 12- Description of Functions

### 12-1 On/Off Function

The control pin 16 (On/Off) can be used for applications requiring On/Off operation. By using an open collector command with a transistor Q referenced to the common terminal (Gi) :

- A logic pulled low (<math><0.2V@1mA</math>, referenced to Gi) on pin 16 disables the converter
- No connection or high impedance on pin 16 enables the converter.

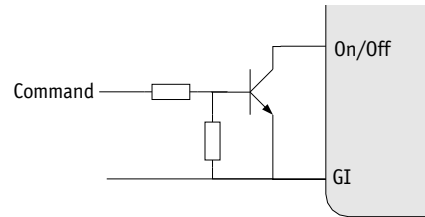

By releasing the On/Off function, the converter will restart within the start-up time specifications given in table page 3. For further details please consult "Logic On/Off" application note.

### 12-2 Trim Function

The primary output voltage Vo1 may be trimmed at +/-5% via a single external trimpot or fixed resistor. The trimpot should be connected as shown in figure hereafter. Value of the trim resistance is given in the following table :

Vo1	R1 Value	Vo1	R1 Value
2,5 V	0 Ohm	12 V	12 KOhm
3,3 V	0 Ohm	15 V	22 KOhm
5 V	0 Ohm	24 V	36 KOhm

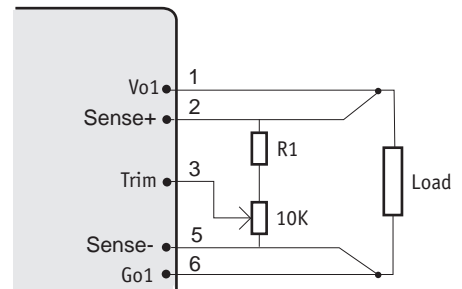

### 12-3 Sense Function

If the load is separated from the output by any line length, some of these performance characteristics will be degraded at the load terminals by an amount proportional to the impedance of the load leads. With the sense function, the voltage at the power supply output shifts by up to the maximum allowed voltage per load line to compensate the voltage drop in the load leads, there by maintaining a constant voltage at the load terminals.

Both Trim and Sense function can be combined but the compensation voltage must not exceed 0.5V max or +/-5% of the output voltage.

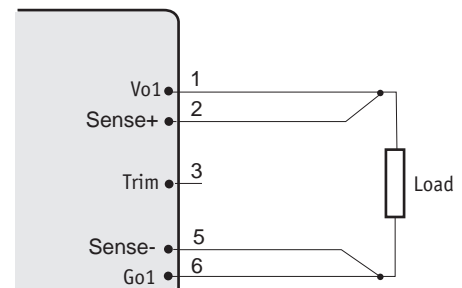

### 13- Application Notes

#### 13-1 Parallel operations

Tethys series can be used in parallel to increase output power. Up to 3 Tethys can be used to add power up to a maximum of 90W. Contact factory for further details.

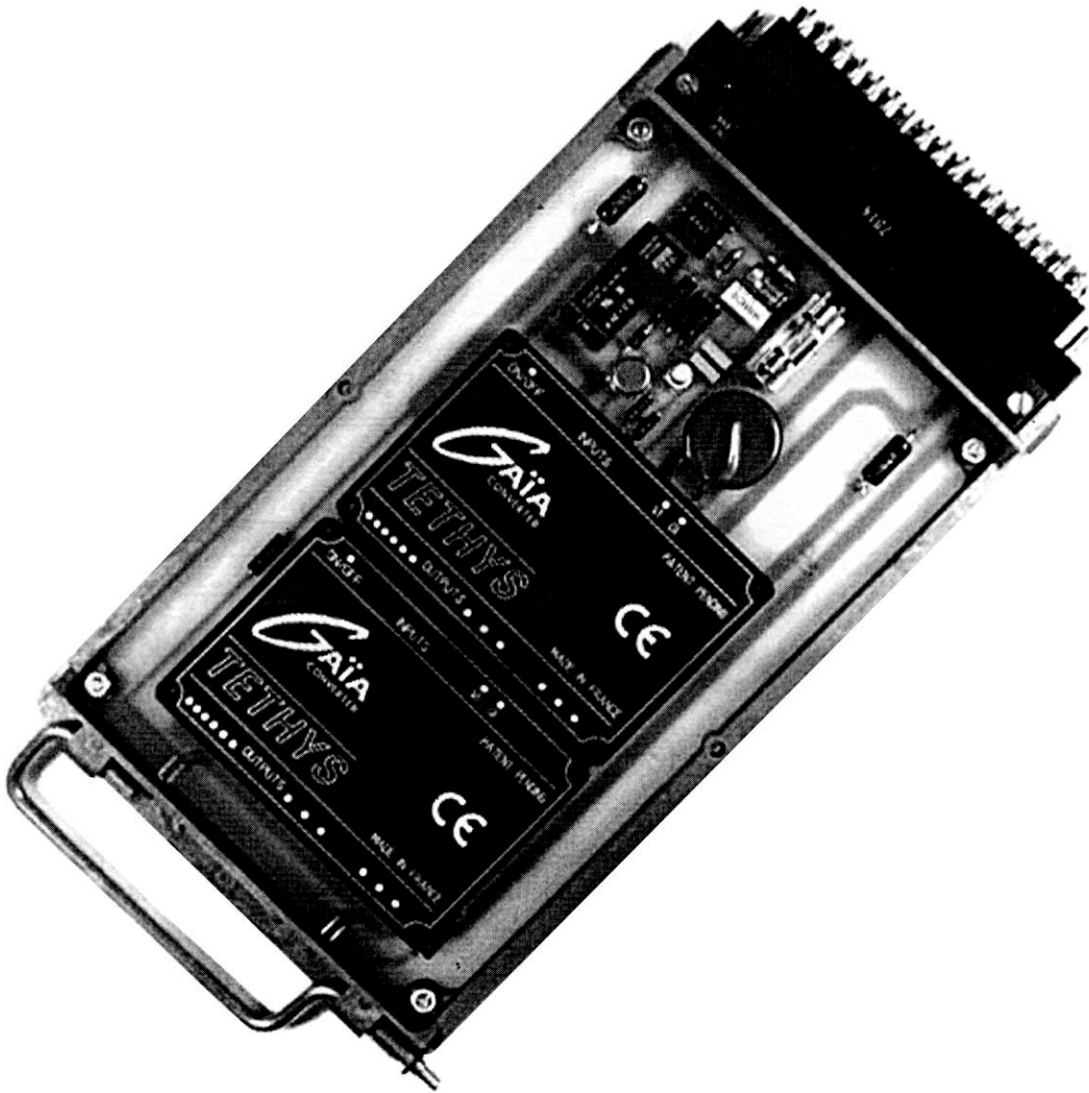

## 14- Dimensions

Dimension are given in mm (inches). Tolerance : +/- 0,2 mm (+/- 0.01 ") unless otherwise indicated.  
Weight : 85 grams (2.9 Ozs) max.

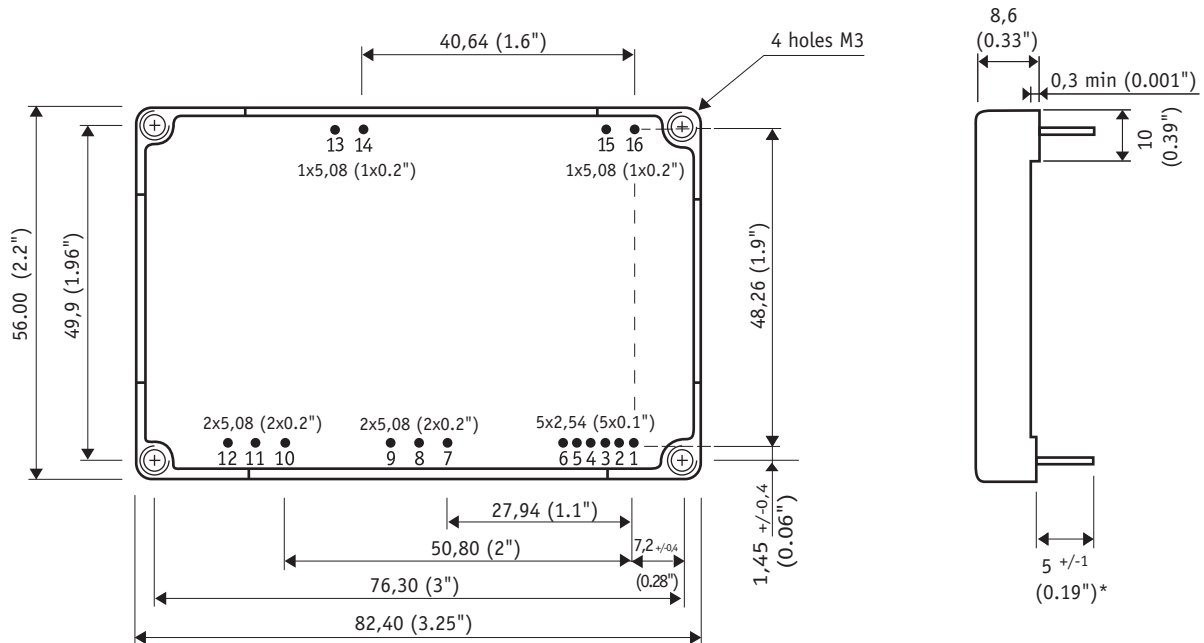

## 15- Materials

Case : Matallic black anodized coating.  
Pins : Plated with pure matte tin over nickel underplate.

Pin dimensions : Ø 0,83mm (0.032")  
\* Except pin 15 : 6 mm (0.23") long

## 16- Product Marking

Upper face : Company logo, location of manufacturing.  
Side face : Module reference, option, date code : year and week of manufacturing.

## 17- Connections

Pin	Single line	Dual line		Triple line					
	1 Output	2 Outputs		3 Outputs		4 Outputs	5 Outputs	6 Outputs	
1	CGDI - □ ▲ 0 - 0 Output 1 + (+Vo1)	CGDI - □ ▲ 0 - ▲ Output 1 + (+Vo1)	CGDI - □ ▲ ▲ 0 - 0 Output 1 + (+Vo1)	CGDI - □ ▲ 0 - ▲ Output 1 + (+Vo1)	CGDI - □ ▲ ▲ 0 - ▲ Output 1 + (+Vo1)	CGDI - □ ▲ ▲ ▲ Output 1 + (+Vo1)	CGDI - □ ▲ ▲ ▲ Output 1 + (+Vo1)	CGDI - □ ▲ ▲ ▲ Output 1 + (+Vo1)	
2	Sense +	Sense +	Sense +	Sense +	Sense +	Sense +	Sense +	Do not connect	
3	Trim	Trim	Trim	Trim	Trim	Trim	Trim	Do not connect	
4	Do not connect	Do not connect	Do not connect	Do not connect	Do not connect	Do not connect	Do not connect	Return 1 (Go1)	
5	Sense -	Sense -	Sense -	Sense -	Sense -	Sense -	Sense -	Do not connect	
6	Return 1 (Go1)	Return 1 (Go1)	Return 1 (Go1)	Return 1- (Go1)	Return 1 (Go1)	Return 1 (Go1)	Return 1 (Go1)	Output 1 - (-Vo1)	
7	Do not connect	Do not connect	Output 2+ (+Vo2)	Do not connect	Output 2 + (+Vo2)	Output 2 + (+Vo2)	Output 2 + (+Vo2)	Output 2 + (+Vo2)	
8	Do not connect	Do not connect	Do not connect	Do not connect	Do not connect	Do not connect	Return 2 (Go2)	Return 2 (Go2)	
9	Do not connect	Do not connect	Return 2 (Go2)	Do not connect	Return 2 (Go2)	Return 2 (Go2)	Output 2 - (-Vo2)	Output 2 - (-Vo2)	
10	Do not connect	Output 2+ (+Vo2)	Do not connect	Output 2+ (+Vo2)	Output 3 + (+Vo3)	Output 3 + (+Vo3)	Output 3 + (+Vo3)	Output 3 + (+Vo3)	
11	Do not connect	Do not connect	Do not connect	Return 2 (Go2)	Do not connect	Return 3 (Go3)	Return 3 (Go3)	Return 3 (Go3)	
12	Do not connect	Return 2 (Go2)	Do not connect	Output 2- (-Vo2)	Return 3 (Go3)	Output 3 - (-Vo3)	Output 3 - (-Vo3)	Output 3 - (-Vo3)	
13	- Input (Gi)	- Input (Gi)	- Input (Gi)	- Input (Gi)	- Input (Gi)	- Input (Gi)	- Input (Gi)	- Input (Gi)	
14	+ Input (Vi)	+ Input (Vi)	+ Input (Vi)	+ Input (Vi)	+ Input (Vi)	+ Input (Vi)	+ Input (Vi)	+ Input (Vi)	
15	Case	Case	Case	Case	Case	Case	Case	Case	
16	On/Off	On/Off	On/Off	On/Off	On/Off	On/Off	On/Off	On/Off	



For more detailed specifications and applications information, contact :

**International Headquarters**

GAIA Converter - France  
ZI de la Morandière  
33185 LE HAILLAN - FRANCE  
Tel. : + (33)-5-57-92-12-80  
Fax : + (33)-5-57-92-12-89

**North American Headquarters**

GAIA Converter Canada, Inc  
4038 Le Corbusier Blvd  
LAVAL, QUEBEC - CANADA H7L 5R2  
Tel. : (514)-333-3169  
Fax : (514)-333-4519

Represented by :