

Asymmetrical - Bridge MOSFET Power Module

$V_{DSS} = 200V$
 $R_{DSon} = 16m\Omega$ typ @ $T_j = 25^\circ C$
 $I_D = 104A$ @ $T_c = 25^\circ C$

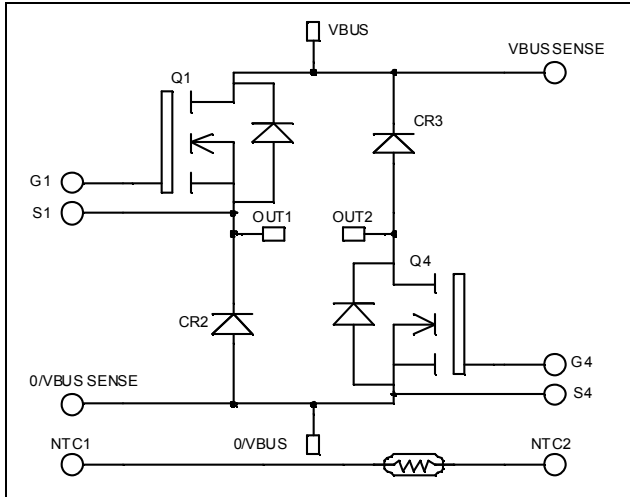

Application

- Welding converters
- Switched Mode Power Supplies
- Switched Reluctance Motor Drives

Features

- Power MOS 7[®] MOSFETs
 - Low R_{DSon}
 - Low input and Miller capacitance
 - Low gate charge
 - Avalanche energy rated
 - Very rugged
- Kelvin source for easy drive
- Very low stray inductance
 - Symmetrical design
 - Lead frames for power connections
- Internal thermistor for temperature monitoring
- High level of integration

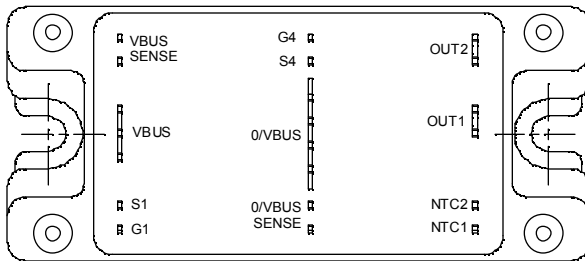

Benefits

- Outstanding performance at high frequency operation
- Direct mounting to heatsink (isolated package)
- Low junction to case thermal resistance
- Solderable terminals both for power and signal for easy PCB mounting
- Low profile
- RoHS Compliant

Absolute maximum ratings

Symbol	Parameter	Max ratings	Unit
V_{DSS}	Drain - Source Breakdown Voltage	200	V
I_D	Continuous Drain Current	$T_c = 25^\circ C$	104
		$T_c = 80^\circ C$	77
I_{DM}	Pulsed Drain current	416	A
V_{GS}	Gate - Source Voltage	± 30	V
R_{DSon}	Drain - Source ON Resistance	19	$m\Omega$
P_D	Maximum Power Dissipation	$T_c = 25^\circ C$	390
I_{AR}	Avalanche current (repetitive and non repetitive)	104	A
E_{AR}	Repetitive Avalanche Energy	50	mJ
E_{AS}	Single Pulse Avalanche Energy	3000	

These Devices are sensitive to Electrostatic Discharge. Proper Handling Procedures Should Be Followed. See application note APT0502 on www.microsemi.com

All ratings @ $T_j = 25^\circ\text{C}$ unless otherwise specified

Electrical Characteristics

Symbol	Characteristic	Test Conditions	Min	Typ	Max	Unit
I_{DSS}	Zero Gate Voltage Drain Current	$V_{GS} = 0V, V_{DS} = 200V$			250	μA
		$V_{GS} = 0V, V_{DS} = 160V$			1000	
$R_{DS(on)}$	Drain – Source on Resistance	$V_{GS} = 10V, I_D = 52A$		16	19	$\text{m}\Omega$
$V_{GS(th)}$	Gate Threshold Voltage	$V_{GS} = V_{DS}, I_D = 2.5\text{mA}$	3		5	V
I_{GSS}	Gate – Source Leakage Current	$V_{GS} = \pm 30V, V_{DS} = 0V$			± 100	nA

Dynamic Characteristics

Symbol	Characteristic	Test Conditions	Min	Typ	Max	Unit
C_{iss}	Input Capacitance	$V_{GS} = 0V$ $V_{DS} = 25V$ $f = 1\text{MHz}$		7220		pF
C_{oss}	Output Capacitance			2330		
C_{rss}	Reverse Transfer Capacitance			146		
Q_g	Total gate Charge	$V_{GS} = 10V$ $V_{Bus} = 100V$ $I_D = 104A$		140		nC
Q_{gs}	Gate – Source Charge			53		
Q_{gd}	Gate – Drain Charge			67		
$T_{d(on)}$	Turn-on Delay Time	Inductive switching @ 125°C $V_{GS} = 15V$ $V_{Bus} = 133V$ $I_D = 104A$ $R_G = 5\Omega$		32		ns
T_r	Rise Time			64		
$T_{d(off)}$	Turn-off Delay Time			88		
T_f	Fall Time			116		
E_{on}	Turn-on Switching Energy	Inductive switching @ 25°C $V_{GS} = 15V, V_{Bus} = 133V$ $I_D = 104A, R_G = 5\Omega$		849		μJ
E_{off}	Turn-off Switching Energy			929		
E_{on}	Turn-on Switching Energy	Inductive switching @ 125°C $V_{GS} = 15V, V_{Bus} = 133V$ $I_D = 104A, R_G = 5\Omega$		936		μJ
E_{off}	Turn-off Switching Energy			986		

Diode ratings and characteristics

Symbol	Characteristic	Test Conditions	Min	Typ	Max	Unit
V_{RRM}	Maximum Peak Repetitive Reverse Voltage		200			V
I_{RM}	Maximum Reverse Leakage Current	$V_R = 200V$	$T_j = 25^\circ\text{C}$		250	μA
			$T_j = 125^\circ\text{C}$		500	
I_F	DC Forward Current			100		A
V_F	Diode Forward Voltage	$I_F = 100A$		1	1.1	V
		$I_F = 200A$		1.4		
		$I_F = 100A$	$T_j = 125^\circ\text{C}$	0.9		
t_{rr}	Reverse Recovery Time	$I_F = 100A$ $V_R = 133V$ $di/dt = 200A/\mu\text{s}$	$T_j = 25^\circ\text{C}$	60		ns
			$T_j = 125^\circ\text{C}$	110		
Q_{rr}	Reverse Recovery Charge		$T_j = 25^\circ\text{C}$	200		nC
			$T_j = 125^\circ\text{C}$	840		

Thermal and package characteristics

Symbol	Characteristic	Min	Typ	Max	Unit	
R _{thJC}	Junction to Case Thermal Resistance	Transistor		0.32	°C/W	
		Diode		0.55		
V _{ISOL}	RMS Isolation Voltage, any terminal to case t=1 min, I _{isol} <1mA, 50/60Hz	2500			V	
T _J	Operating junction temperature range	-40		150	°C	
T _{STG}	Storage Temperature Range	-40		125		
T _C	Operating Case Temperature	-40		100		
Torque	Mounting torque	To Heatsink	M5	2.5	4.7	N.m
Wt	Package Weight				160	g

Temperature sensor NTC (see application note APT0406 on www.microsemi.com for more information).

Symbol	Characteristic	Min	Typ	Max	Unit
R ₂₅	Resistance @ 25°C		50		kΩ
B _{25/85}	T ₂₅ = 298.15 K		3952		K

$$R_T = \frac{R_{25}}{\exp\left[B_{25/85}\left(\frac{1}{T_{25}} - \frac{1}{T}\right)\right]}$$

T: Thermistor temperature
 R_T: Thermistor value at T

SP4 Package outline (dimensions in mm)

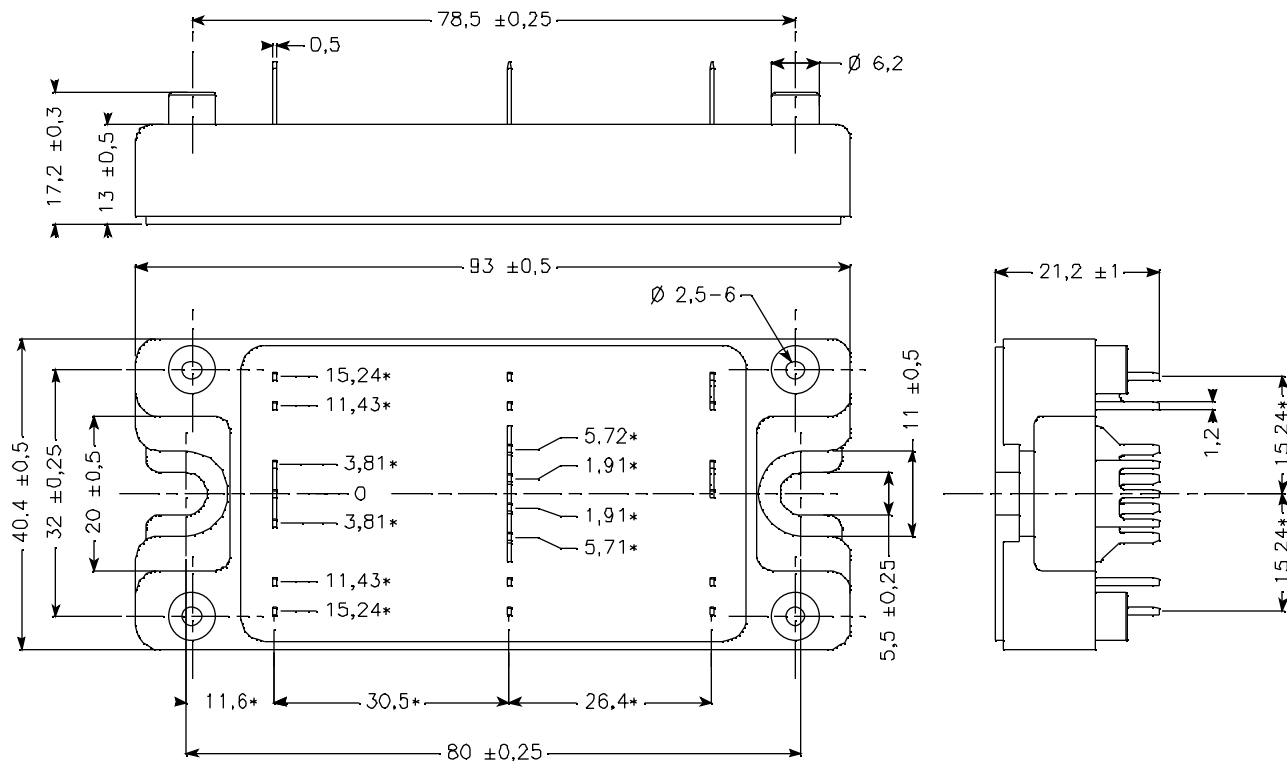

ALL DIMENSIONS MARKED "*" ARE TOLERANCED AS: $\text{M} \pm 0.1$

See application note APT0501 - Mounting Instructions for SP4 Power Modules on www.microsemi.com

Typical Performance Curve

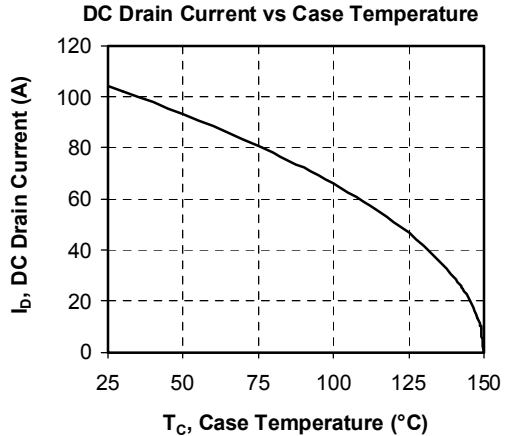
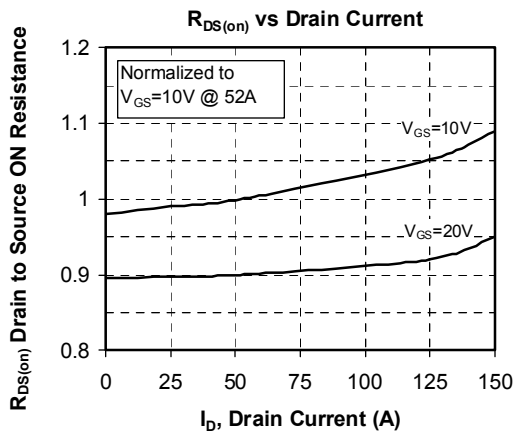
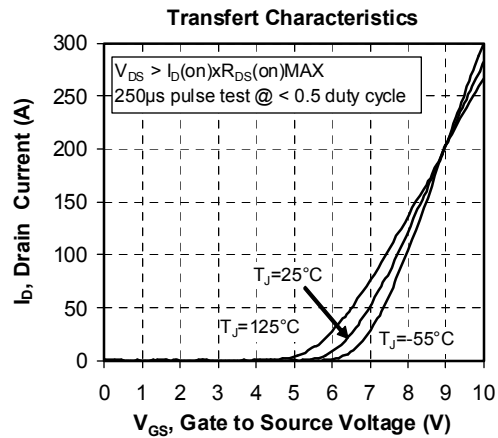
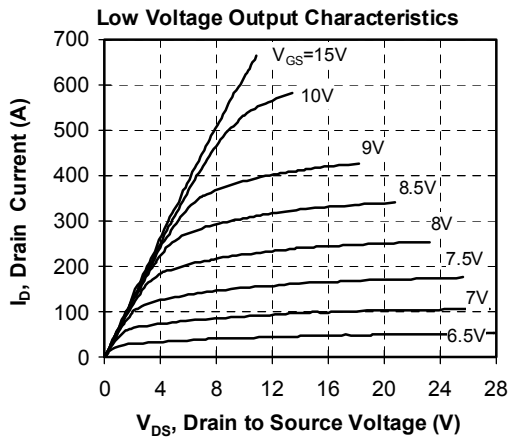
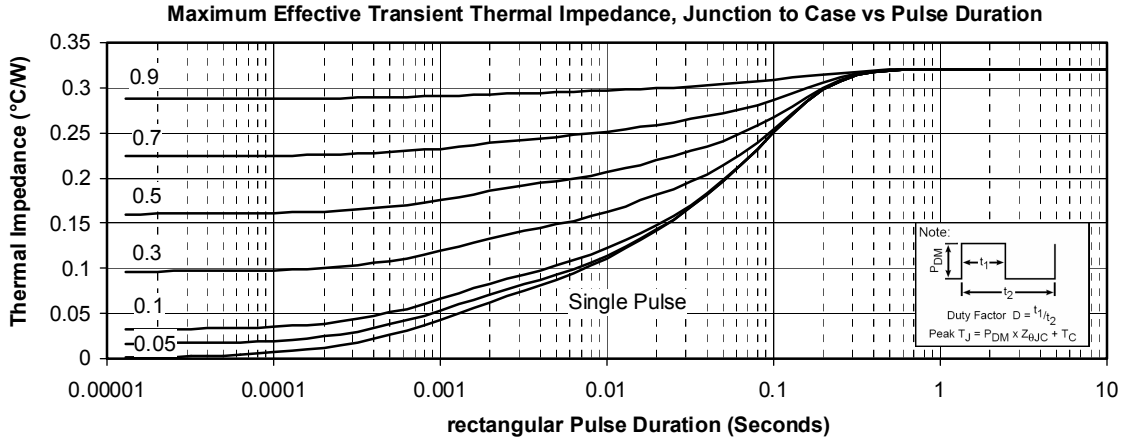

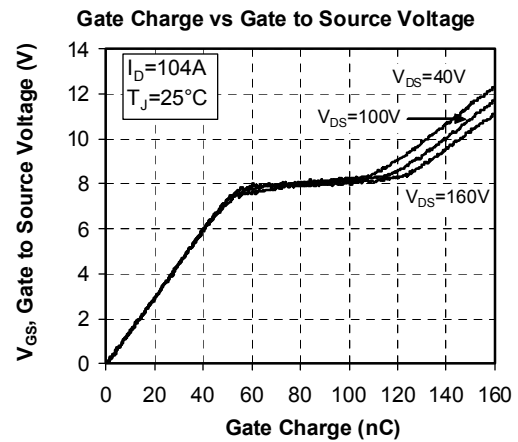
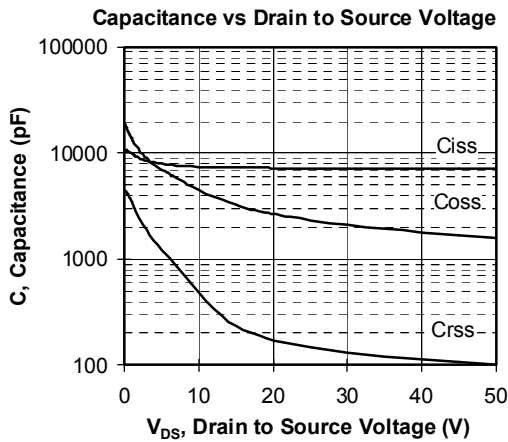
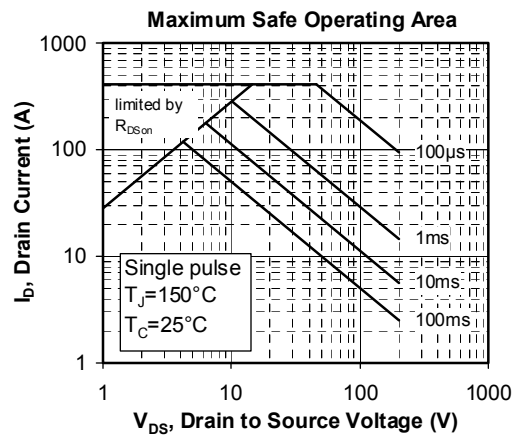
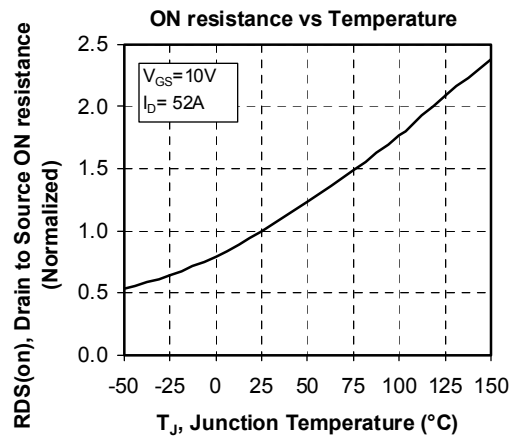

Delay Times vs Current

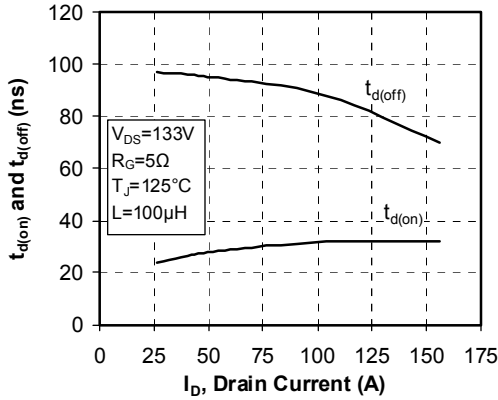

Rise and Fall times vs Current

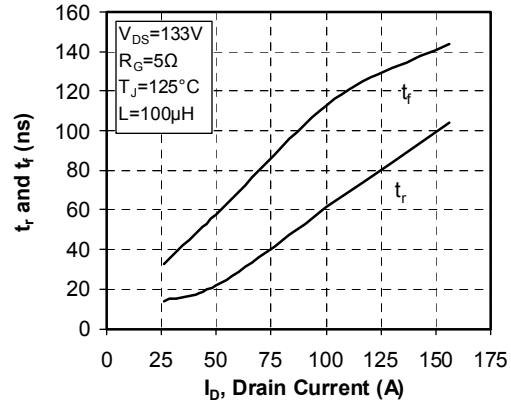

Switching Energy vs Current

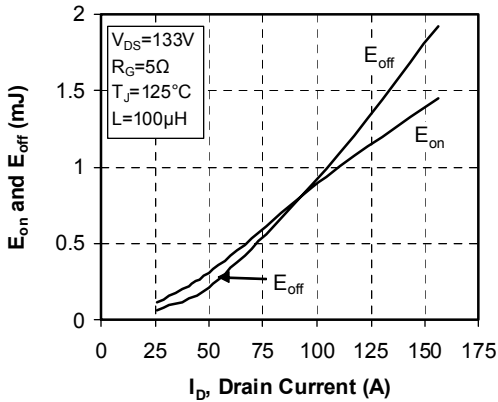

Switching Energy vs Gate Resistance

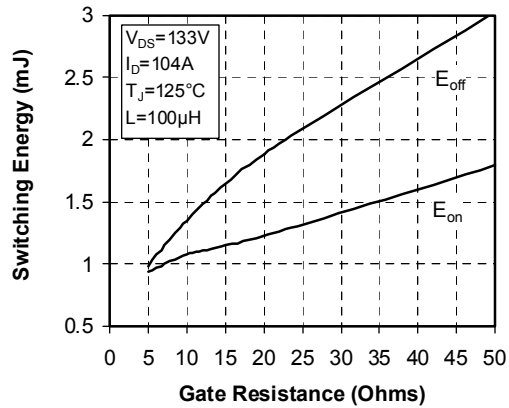

Operating Frequency vs Drain Current

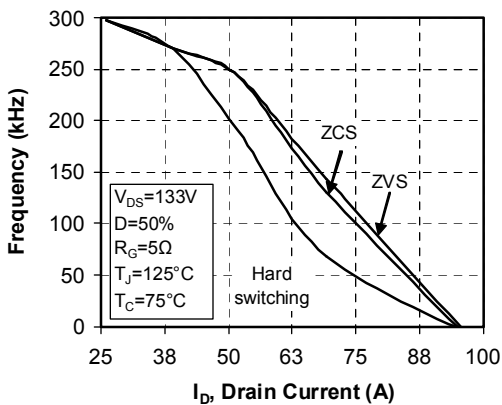

Source to Drain Diode Forward Voltage

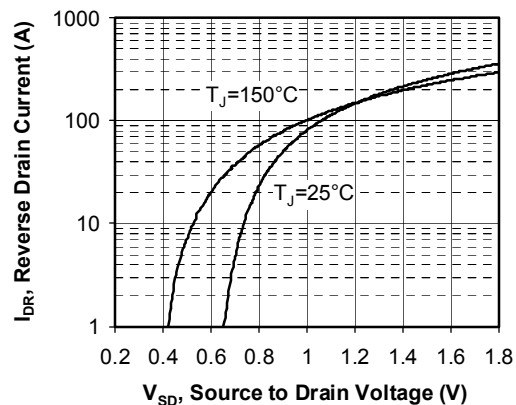

Microsemi reserves the right to change, without notice, the specifications and information contained herein

Microsemi's products are covered by one or more of U.S. patents 4,895,810 5,045,903 5,089,434 5,182,234 5,019,522 5,262,336 6,503,786 5,256,583 4,748,103 5,283,202 5,231,474 5,434,095 5,528,058 and foreign patents. U.S. and Foreign patents pending. All Rights Reserved.